

AdderView Prism

User Guide

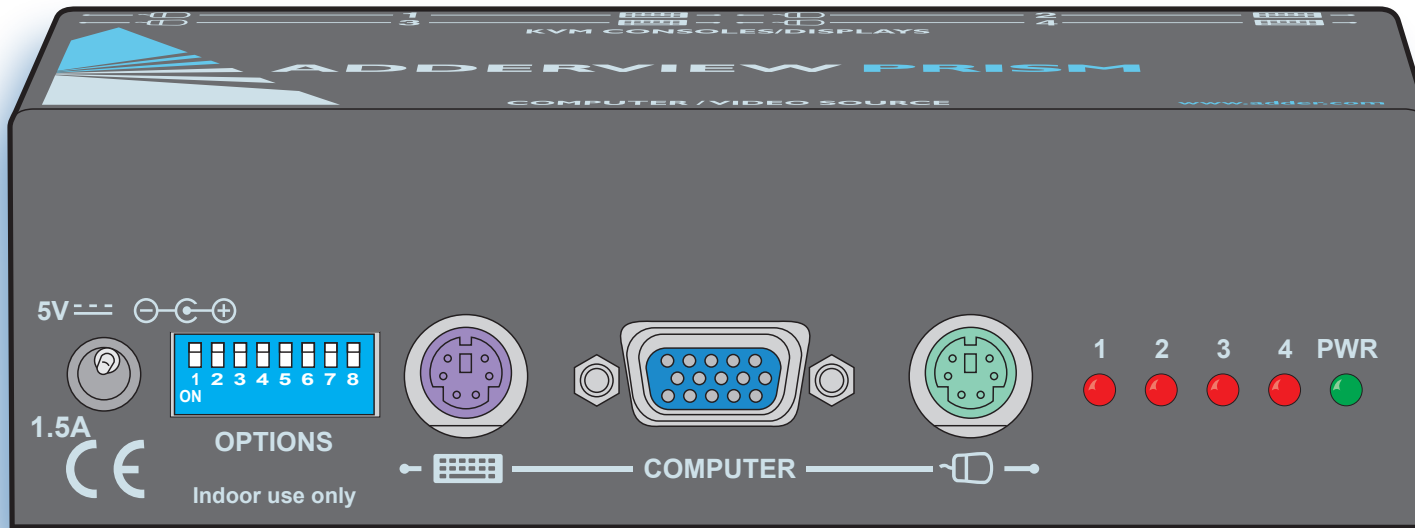

[CONTENTS](#)

Contents



Welcome

Introduction	2
Video splitter	3
Typical AdderView Prism applications.....	3
Square matrix.....	3
Resource sharer/contender.....	3
AdderView Prism features - front and rear	4
What's in the box	5
What you may additionally need	5

Installation and Operation

Mounting	6
Connections	6
Cable lengths	6
Host computer or KVM switch	7
Keyboards, video monitors and mice	7
Power supply (use is optional)	8
Do I need to use the power supply?	8
Operation.....	9
User arbitration and keyboard indicators	9
AdderView Prism indicators	9
Video boost feature.....	9
Resetting AdderView Prism	9

Special configuration

Configuration switches	10
Using configuration options.....	11
Hotkey combinations.....	11
Mouse speed timing adjustment	11
Miscellaneous functions	11
Hot plugging and mouse restoration.....	12
Which restore setting do I use?	12
AdderView Prism software upgrade	13
Stage A - Download the upgrade file	13
Stage B - Create a startup diskette and copy files to it	14
Stage C - Place the AdderView Prism in upgrade mode and re-boot	14

Further information

Getting assistance.....	15
Other products in the Adder range.....	16
Warranty	16
Safety information	16
Radio Frequency Energy	17

Index

WELCOME

INSTALLATION
& OPERATION

SPECIAL
CONFIGURATION

FURTHER
INFORMATION

INDEX

Welcome

Introduction

The AdderView Prism provides a flexible method for allowing two or more users to share resources. Depending on how it is connected, the AdderView Prism can be used to drive up to four video displays ([video splitting](#)), allow up to four users to access a KVM switch ([resource sharing](#)) or, in conjunction with other similar units and KVM switches, provide the opportunity for many users to connect with many different systems ([square matrix](#)).

AdderView Prism supports a wide 280MHz bandwidth that can support very high screen resolutions of 1600 x 1280 and even 1900 x 1440 (with standard cables). When long cable runs (of up to 30m) are required, AdderView Prism features a video boost option to ensure that picture quality remains crisp.

Thanks to smart power control, the use of the supplied external power supply is optional for most applications. This can be handy when spare power sockets are not close at hand.

AdderView Prism uses standard connectors throughout for quick and easy connection to host systems and peripherals alike.

Up to four users served on a first come basis

Up to four users can simultaneously view the output from the host system. Any of the users can take control of the host, providing it is not being used by one of the others. A user relinquishes control two seconds after their last key press or mouse movement.

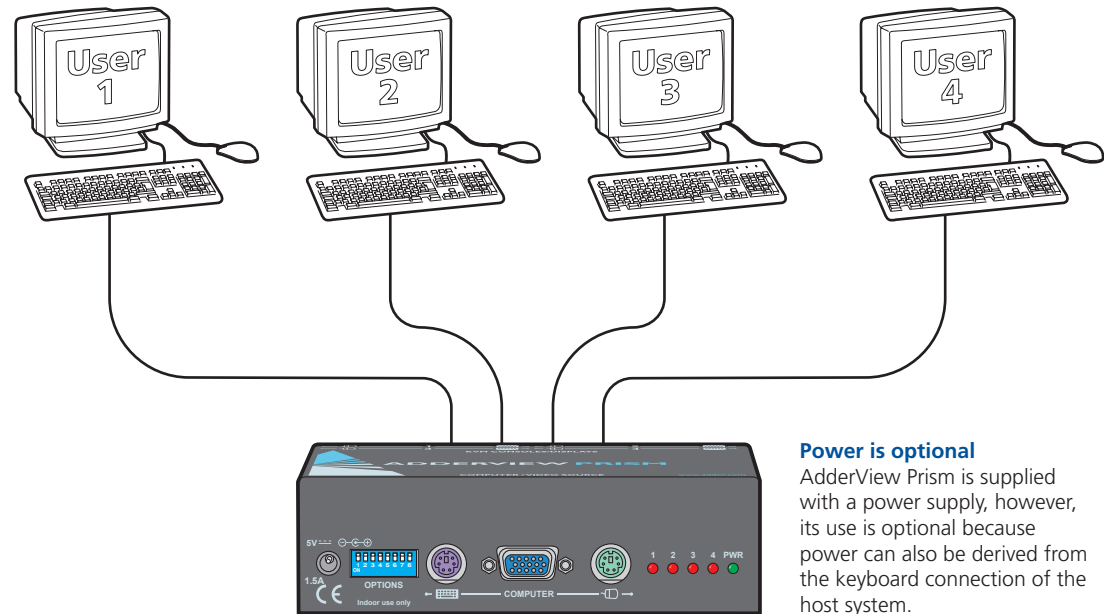

Power is optional

AdderView Prism is supplied with a power supply, however, its use is optional because power can also be derived from the keyboard connection of the host system.

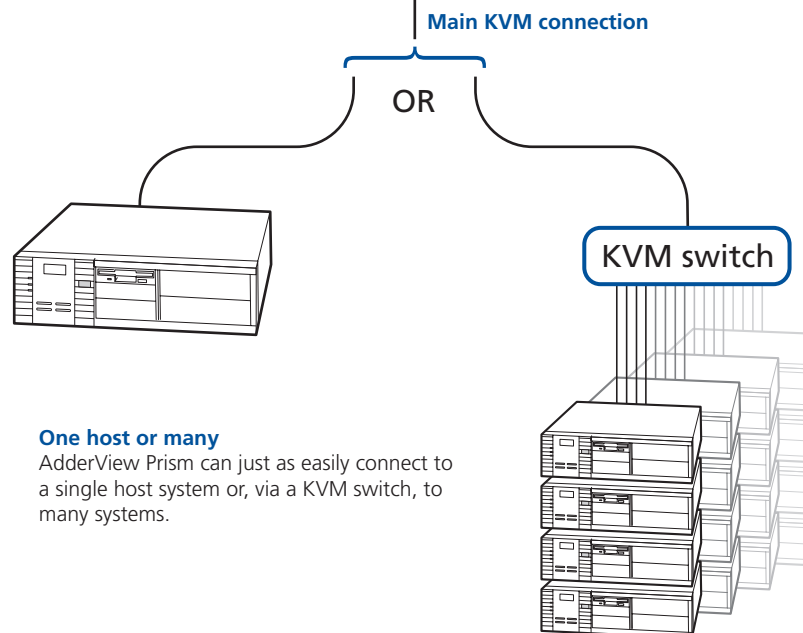

One host or many

AdderView Prism can just as easily connect to a single host system or, via a KVM switch, to many systems.



WELCOME

INSTALLATION
& OPERATION

SPECIAL
CONFIGURATION

FURTHER
INFORMATION

INDEX

Typical AdderView Prism applications

The flexibility and adaptability of the AdderView Prism becomes clear when you see some of its typical uses.

Video splitter

A quick and easy way to distribute high quality video to multiple locations. The internal video boost feature assists when making long cable runs to remote monitors.

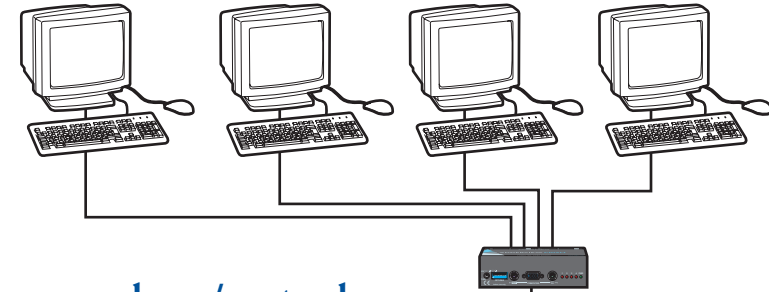
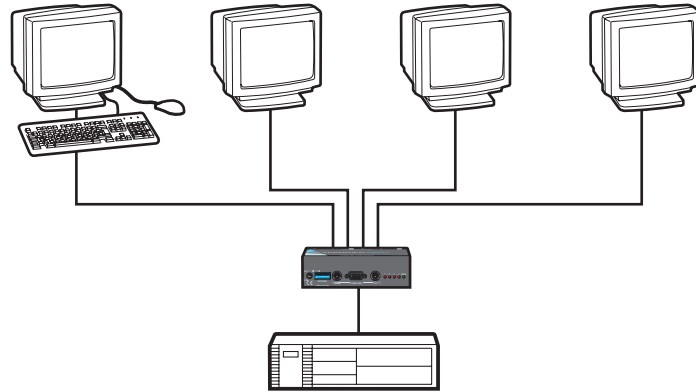

Resource sharer/contender

Allows common resources to be shared between up to four users. Typical applications include general server management from different desks; trading floor systems where shared information is vital.

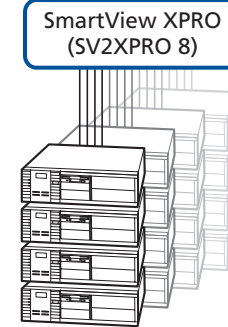

Square matrix

This application permits multiple users simultaneous access to any systems. A clever arrangement of AdderView Prism and suitable KVM switches, such as the Adder SmartView XPRO, ensures sufficient redundancy that everyone can access a system of their choice. The AdderView Prism units communicate with the SmartView XPRO boxes to indicate clearly to a user when a particular system is already in use.

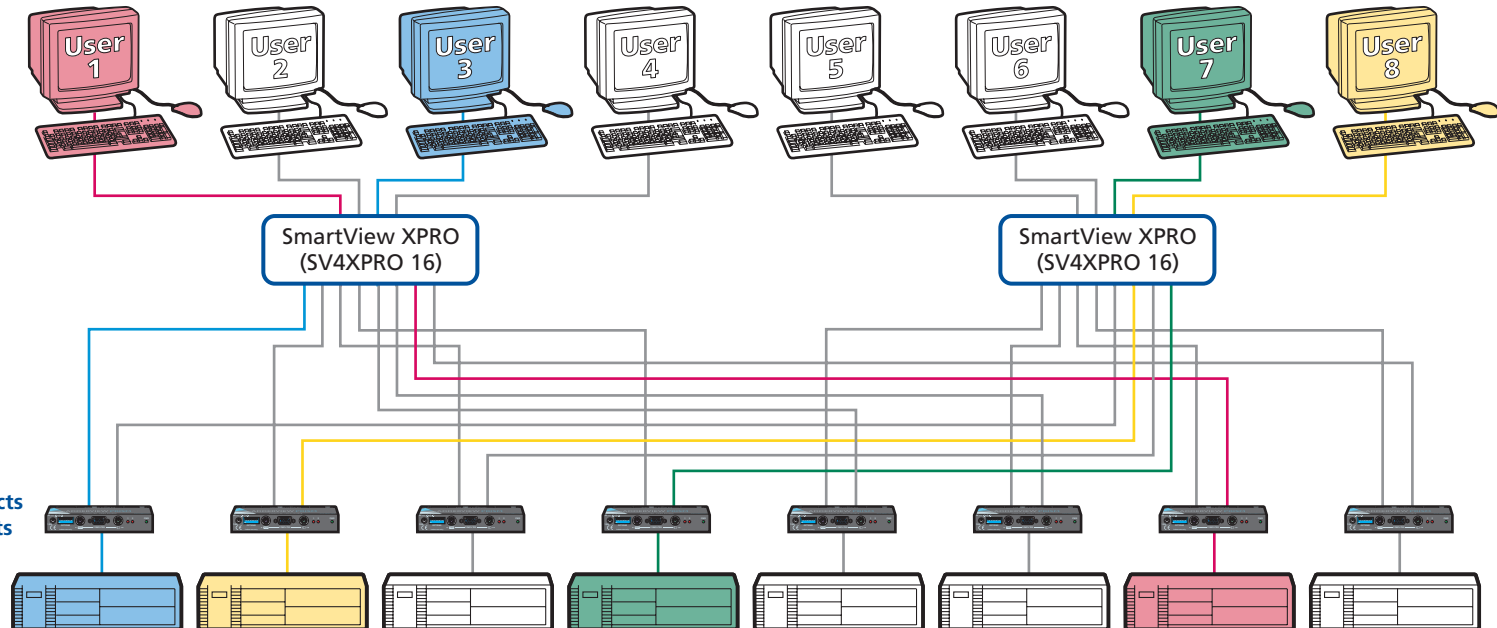

Each AdderView Prism connects to both SmartView XPRO units

AdderView Prism features - front and rear

AdderView Prism is available in two port and four port versions. Both versions offer compact casings, straightforward connections and reliable operation.



Front view - 2 port version

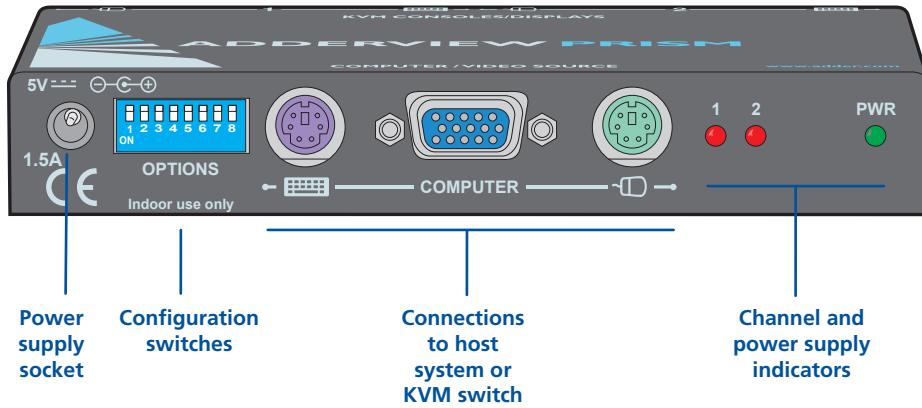

Rear view - 2 port version

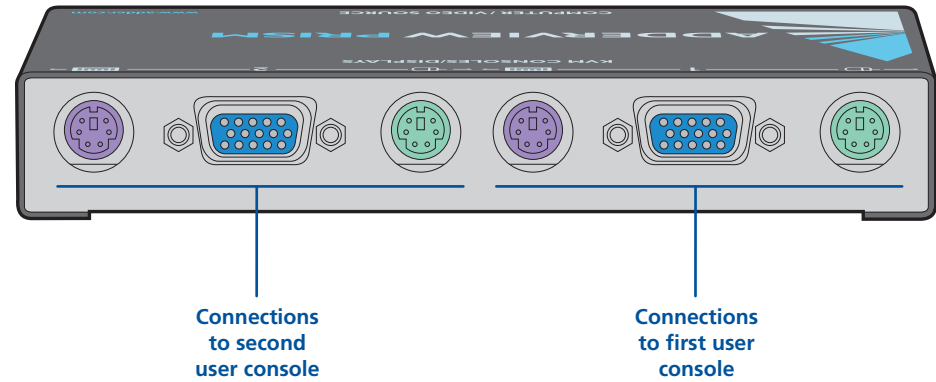

Front view - 4 port version

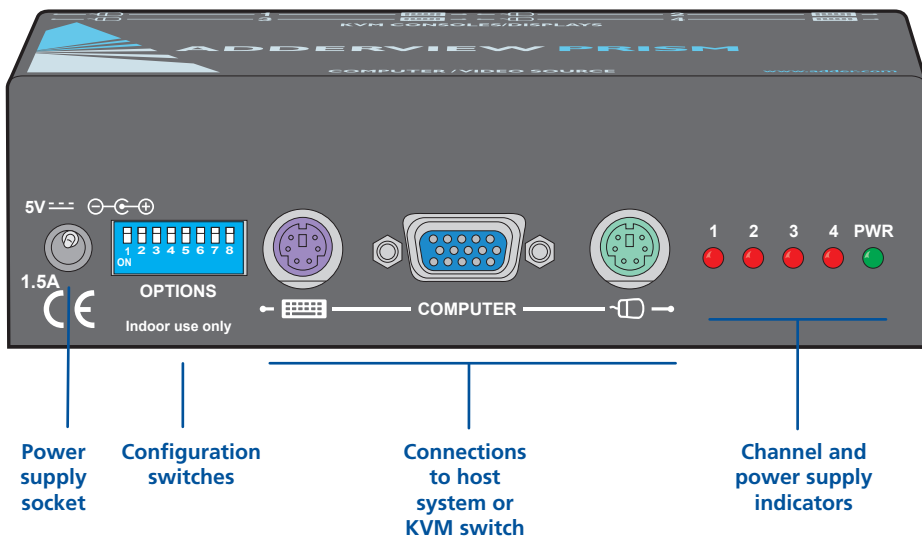

Rear view - 4 port version

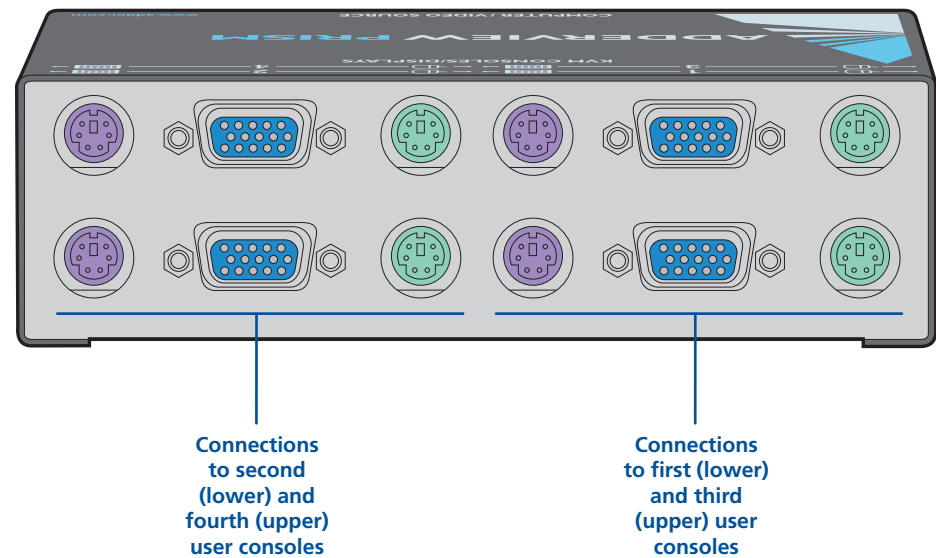

WELCOME

INSTALLATION & OPERATION

SPECIAL CONFIGURATION

FURTHER INFORMATION

INDEX

What's in the box

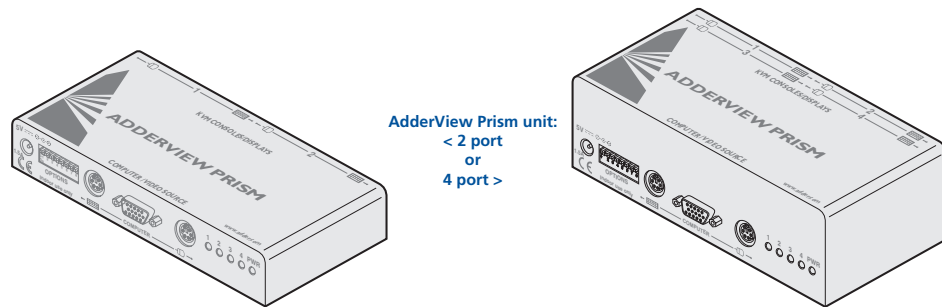

AdderView Prism unit:
< 2 port
or
4 port >

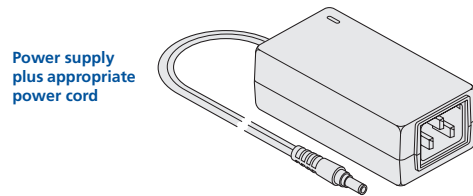

**Power supply
plus appropriate
power cord**

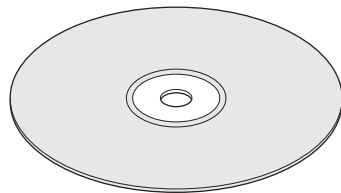

**CD-ROM &
safety leaflet**

**Four self-adhesive
rubber feet**

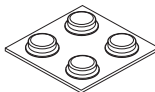

What you may additionally need

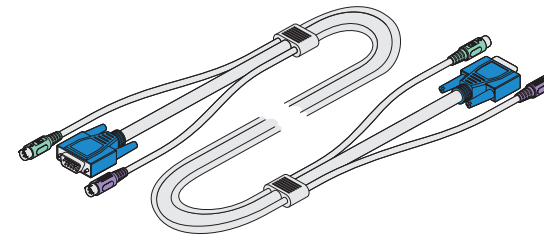

KVM cables
One set per connected computer
Part number: VKVM-xM
(where x is the cable length in
metres: 1, 2, 5 or 10)

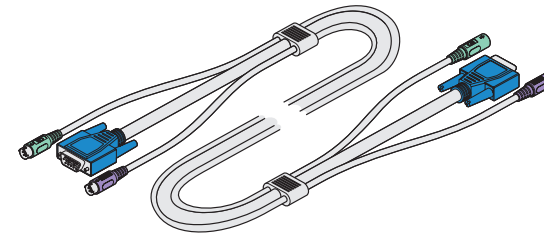

Extension cables
One set per connected KVM
console when they are placed some
distance from the AdderView Prism.
Part number: VEXT-xM
(where x is the cable length in
metres: 2, 5 or 10)

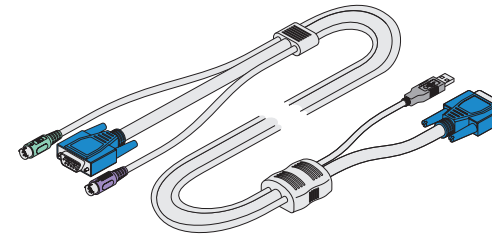

CCUSB converter
Required to connect with computers
that use a USB port to connect their
keyboard and mouse
Part number: CCUSB-xM
(where x is the cable length in metres:
2, 5 or 10)

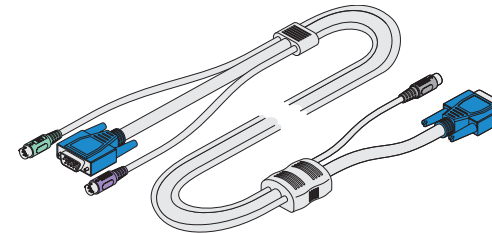

CCSUN converter
Required to connect Sun computers
that use a mini-DIN port to connect
their keyboard and mouse
Part number: CCSUN-xM
(where x is the cable length in metres:
2, 5 or 10)

PS/2 to AT-style keyboard converter
(part number: VSA3)

Rack mount unit

Rack mount options are available to fit up to sixteen 2-port Prisms or up to eight 4-port units in a 19 inch rack - please contact Adder Technology for details.

Installation and Operation



Mounting

AdderView Prism offers two main mounting methods:

- Supplied four self-adhesive rubber feet
- Optional rack mount assembly to hold up to eight 4-port AdderView Prism units or up to sixteen 2-port AdderView Prism units.

Connections

Installation of the AdderView Prism involves a number of basic connections to some or all of the following items:

- [Host computer or KVM switch](#)
- [Keyboards, video monitors and mice](#)
- [Power supply \(use is optional\)](#)

Cable lengths

The AdderView Prism uses high quality powered circuitry to prevent signal degradation. When used in conjunction with the accompanying power supply, this means that you can use relatively long cable links between the AdderView Prism, the system and the user console or KVM switch. The lengths of cables that can be used for given situations are summarised below.

Video resolutions of up to 1600 x 1280 are supported on longer cable lengths while higher resolutions of up to 1900 x 1440 may be used with shorter links.

The AdderView Prism also features a video boost feature to ensure that picture quality remains sharp over longer distances. See [Configuration switches - Video signal boost \(switch 2\)](#) for more information.

Cable position	Used without power supply	Used with power supply
AdderView Prism to Console	2m*	10m**
AdderView Prism to System	2m	20m**

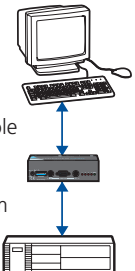

Note: The total cable length (from system through to console) should not exceed 30m.

* Cable lengths can be increased to 5m when used in square matrix formation (in conjunction with KVM switches).

** For video only applications (i.e. without keyboard or mouse), any 'video only' link cable may be up to 30m long provided the overall cable run (i.e. including the cable on the other side of the AdderView Prism) does not exceed 32m.

WELCOME

INSTALLATION
& OPERATION

SPECIAL
CONFIGURATION

FURTHER
INFORMATION

INDEX

Host computer or KVM switch





The AdderView Prism can either connect directly to a single host computer or to range of hosts via one or more KVM switches.

To connect a host computer or KVM switch

- 1 Ensure that power is disconnected from the computer or KVM switch to be connected.

(Note: If it is not possible to switch off devices prior to connection, then a 'Hot plug' procedure is available – see the [Hot plugging and mouse restoration](#) section for more details).

- 2 Connect the plugs at one end of a KVM cable set to the keyboard, video and mouse sockets of the computer or KVM switch.

Monitor (video)		Blue
Keyboard		Purple
Mouse	 or 	Mid green

- 3 Connect the plugs at the other end of the KVM cable set to the corresponding sockets, collectively labelled as 'COMPUTER', on the front panel of the AdderView Prism.

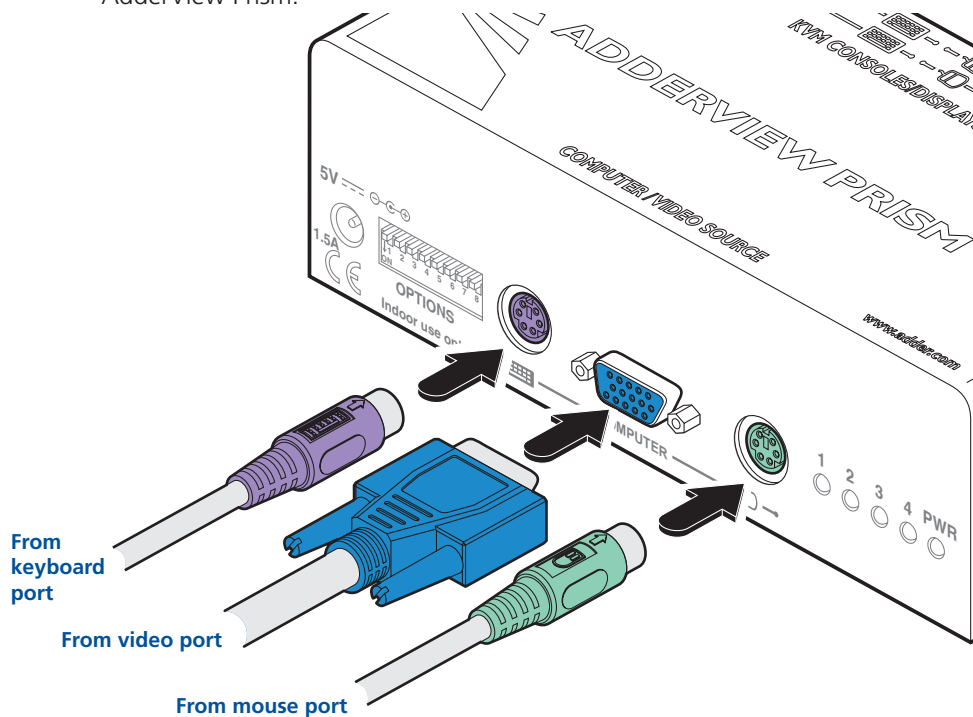

Keyboards, video monitors and mice

The rear panel provides sets of ports (either two or four, depending on the AdderView Prism model) and each accommodates a keyboard, video monitor and mouse connection.

The ports can be connected and used in any order (see note 2 below), and not all connectors of each port need to be used. For instance, when AdderView Prism is used as a video splitter, usually only the video connections are utilised.

Where a user will be situated close to the AdderView Prism, the keyboard, video monitor and mouse can be connected directly. When a user will be placed some distance away, then an extender cable should be used. See [What you may additionally need](#) for part numbers.

Note 1: In square matrix configurations, these rear panel ports would be connected to the CPU/computer ports of suitable KVM switches.

Note 2: At power on, AdderView Prism attempts to gain information about the capabilities of connected monitors (using the Display Data Channel [DDC] format) by interrogating the monitor at port 1. If you are using a mixture of monitors, it is advantageous to place one that supports DDC at port 1.

To connect a keyboard, video monitor and mouse

- 1 Position a suitable keyboard, video monitor and mouse in the required location. Where the distance to the AdderView Prism is greater than the cable lengths use suitable extender cables (see [What you may additionally need](#)).
- 2 Connect the keyboard, video monitor and mouse plugs to the sockets of one of the ports (labelled between 1 and 4) at the rear panel of the AdderView Prism.

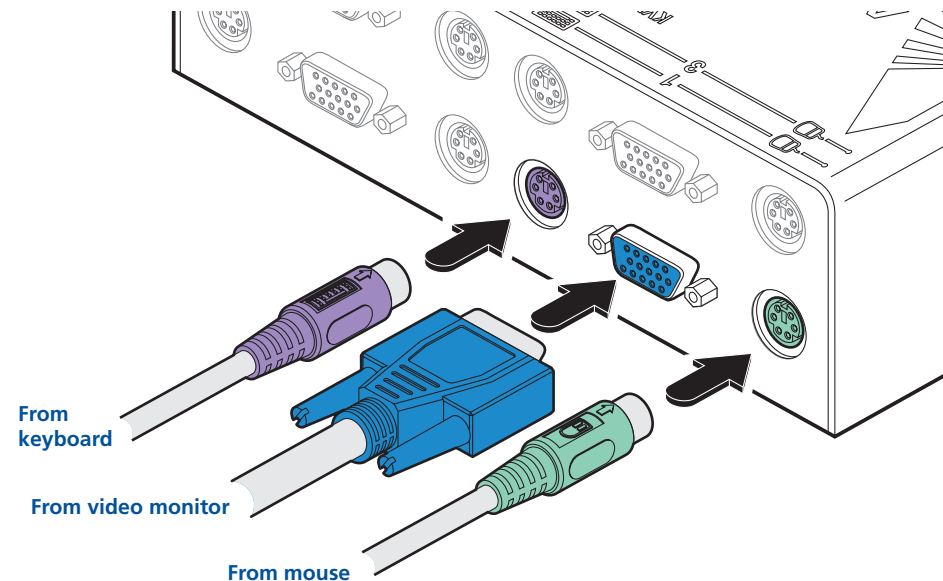

Power supply (use is optional)

The AdderView Prism is supplied with a power supply and an appropriate country-specific IEC power cord. There is no on/off switch so operation begins as soon as the power supply is connected.

The use of the power supply is optional because the AdderView Prism can also derive its power from the keyboard port of the host system or KVM switch. Where up to four standard keyboards and mice are connected to the AdderView Prism (and standard length cables are used), it is usually possible to power the AdderView Prism purely from the host system or KVM switch. See opposite for more information.

IMPORTANT: If the power supply will NOT be used, click switch 1 on the front panel down to its ON position. See [Configuration switches - Power source selection \(switch 1\)](#) for more information).

To connect the power supply

- 1 Connect the low voltage output connector from the power supply unit to the power socket on the front panel of the AdderView Prism.

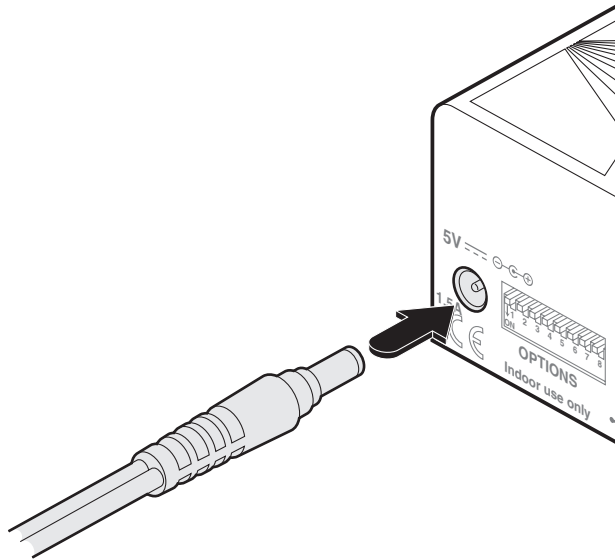

- 2 Connect the IEC connector of the supplied country-specific power cord to the socket of the power supply.
- 3 Connect the power cord to a nearby main supply socket.

Do I need to use the power supply?

Thanks to smart power control, the use of the supplied external power supply is optional for most applications because the AdderView Prism can be configured to derive its power from the host system.

The following two main factors will determine whether you can use the AdderView Prism with, or without the power supply:

1: Lengths of cables to host computer and to consoles

- | | |
|--|---------------------------|
| A All cables 2m or less | Power supply not required |
| B Any cables 2.2m or more | Power supply required |

2: Power required by all connected keyboards and mice

- | | |
|--|---------------------------|
| A Total requirement is 400mA or less* | Power supply not required |
| B Total requirement is 420mA or more* | Power supply required |

If *either* of the above factors meet the **B** scenario, then you need to use the power supply.

* How to check power requirements

You can determine the overall power required by the connected keyboard and mice by consulting their product labels. On the underside of almost all keyboard and mice will be a label stating their power requirements.

This figure is usually represented as a voltage (e.g. 5V) and a current (e.g. 20mA).

- Most standard keyboards require around 50mA
- Most standard mice require around 20 - 25mA.

Add up the total current requirements for all connected devices. If the total value is 400mA or less then you do not need to use the power supply (subject to the cable lengths being 2m or shorter).

Operation

User arbitration and keyboard indicators

During operation, all of the connected video monitors continuously receive the output from the host system (or KVM switch). Control of the host system is arbitrated by the AdderView Prism on a first come, first served basis. In the idle state, control is available to all users and their keyboard indicators all show the current Num Lock, etc. conditions of the host system.

At the moment that a key is pressed or a mouse is moved, the keyboards and mice of the other users are temporarily locked-out (the video images remain). The keyboard indicators of the locked-out users then begin to flash to confirm their status:

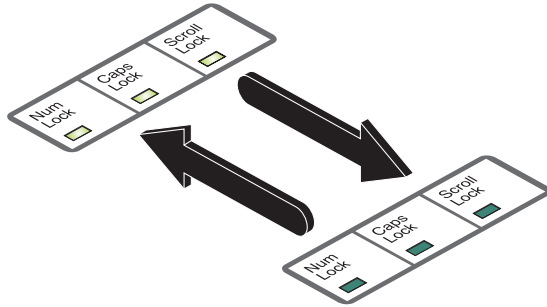

After two seconds of inactivity from the user currently in control, the AdderView Prism returns to its idle condition and the re-instates the keyboard indicators of the locked-out users.

AdderView Prism indicators

The red indicators on the front panel of the AdderView Prism illuminate to show which user currently has control.

The green indicator illuminates when the power supply is connected and switched on.

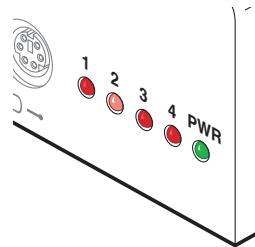

Video boost feature

The AdderView Prism offers a video boost feature which provides amplification to compensate for losses introduced by long video cables. The effect of this is to ensure that the video images remain sharp even at high resolutions over relatively long distances.

To enable video boost

- Click switch 2 (AdderView Prism may be powered on or off) down into its ON position.

Resetting AdderView Prism

A reset option is provided.

To reset the AdderView Prism

- Momentarily click switch 3 down into its ON position and then back up to its OFF state.



WELCOME

INSTALLATION
& OPERATION

SPECIAL
CONFIGURATION

FURTHER
INFORMATION

INDEX

Special configuration



For many installations, no further configuration will be required once the host system and user consoles are connected. This chapter covers the various special configuration options that may be required in certain cases.

Configuration switches

The AdderView Prism front panel features a set of eight mini switches which are used to determine a number of options:

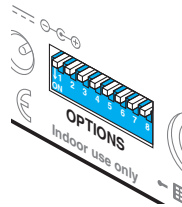

Action	Switch
Power source selection	1
Video signal boost	2
Reset AdderView Prism	3
Enter configuration mode	6
Enter upgrade mode at power on	7

Note 1: Switches 4, 5 and 8 are reserved for future use.

Note 2: When changing switch positions the Prism can be powered on or off.

Power source selection (switch 1)

This switch determines how the AdderView Prism derives its power.

- OFF Draw power only from the power adaptor.
- ON Draw power from power adaptor, if present, or alternatively use power from the host system keyboard port.

Note 3: The AdderView Prism is fitted with an auto-resettable fuse rated at 500mA. If the total power drawn by the connected keyboards and mice is approaching, or exceeds 400mA, then the power adaptor must be used.

Note 4: The power adaptor must be used if the AdderView Prism is to be cascaded with other similar units or interface-powered KVM switches or extenders.

Video signal boost (switch 2)

This switch selects video boost mode which gently amplifies the video signal and is particularly useful for improving picture quality when long video cable lengths are used.

- OFF No video boost
- ON Apply video boost

Reset AdderView Prism (switch 3)

Use this option to reset the AdderView Prism. Change the switch to the ON position momentarily and then OFF again to achieve the reset.

- OFF Normal operation.
- ON Reset AdderView Prism (change back to OFF position to complete the reset).

Enter configuration mode (switch 6)

Allows you to alter key aspects of AdderView Prism operation. Within configuration mode you can use any connected keyboard to enter specific key combinations. See [Using configuration options](#) for a full list of key combinations.

- OFF Normal operation.
- ON Enter configuration mode (change back to OFF once configuration options have been entered).

Enter upgrade mode at power on (switch 7)

Places the AdderView Prism into a special state whereby you can rewrite its internal operating software. After placing this switch into its ON position, you need to cycle the power input or briefly use switch 3 to reset the AdderView Prism. See [AdderView Prism software upgrade](#) for full details about the upgrade procedure.

- OFF Normal operation.
- ON Enter upgrade mode following the next reset or power on.

Using configuration options

Configuration mode allows you to alter key aspects of AdderView Prism operation. Within configuration mode you can use any connected keyboard to enter specific key combinations to bring about the required change in operation. Configuration mode is instigated by changing switch 6 to its ON position, the required configuration option is then selected by entering a particular combination of letter and number.

To use configuration options (a quick summary):

- 1 Enter configuration mode (click switch 6 down into its ON position).

All of the AdderView Prism front panel indicators will light as well as all three of the keyboard indicators ('Num Lock', 'Caps Lock' and 'Scroll Lock'). Your AdderView Prism is now ready to accept new configuration options.

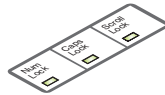

- 2 Type the letter of the required option, (e.g. H).

On your keyboard, the 'Scroll Lock' indicator will darken, leaving the 'Num Lock' and 'Caps Lock' indicators lit – this indicates that a configuration option number is now required.

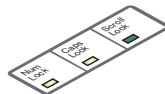

- 3 Type the number of the required option, (e.g. 3).

On your keyboard, the 'Caps Lock' indicator will darken, leaving only the 'Num Lock' indicator lit – this indicates that you need to confirm the configuration option that you just typed.

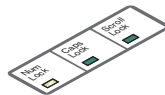

- 4 Press .

All three of the keyboard indicators will re-light.

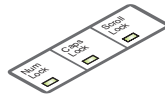

- 5 Enter another option or exit from configuration mode (return switch 6 to its OFF position).

All indicators will return to their original conditions.

Hotkey combinations

Hotkeys signal to the AdderView Prism that you wish to talk to it (using the keyboard) rather than the computer. However, you may find that the standard hotkeys interfere with other devices or software. In such cases, you can change the hotkeys to a different combination of two keys. These configuration options allow you to determine which keyboard keys are used as the hotkeys. See [Hot plugging and mouse restoration](#) for details about using hotkeys to restore mouse operation.

- H1 Hotkey combination is LEFT ALT + RIGHT ALT + command key (default setting).
- H2 Hotkey combination is CTRL + SHIFT + command key.
- H3 Hotkey combination is ALT + SHIFT + command key.
- H4 Hotkey combination is RIGHT ALT + command key.
- H5 Hotkey combination is CTRL + ALT + command key.
- H6 Hotkey combination is LEFT CTRL + LEFT ALT + command key.
- H7 Hotkey combination is RIGHT CTRL + RIGHT ALT + command key.

Mouse speed timing adjustment

These configuration options allow you to overcome a rare timing problem caused by certain mouse, computer and switch combinations. The problem can occur when the mouse driver software and computer are over-sensitive to timing changes within the information from the mouse. Adding a switch, such as the AdderView Prism, can cause slight timing changes that result in the on-screen mouse pointer responding very slowly. Choosing the L6 option helps to counteract the rare problem that is known to occur in combinations such as an HP Vectra running later versions of Windows NT, using a Logitech mouse driver and a Logitech mouse.

- L5 Do not adjust mouse speed timings (default setting).
- L6 Adjust mouse speed timings to solve response problems.

Miscellaneous functions

Note: These functions use the letter 'F'. As with all of the other configuration options, press the letter and then the number, i.e. F and then 1 – not the 'F1' function key.

- F1 Declare the AdderView Prism firmware version. When selected, the version number will be sent to the currently selected computer – ensure that a suitable application is running (such as a notepad or word processor) so that the version number may be displayed on screen.
- F8 RESET all configuration options to the default settings.



Hot plugging and mouse restoration

It is strongly recommended that you switch off the host system or KVM switch before attempting to connect your AdderView Prism. However, if this is not possible then you need to 'hot plug' your AdderView Prism while power is still applied to the system. There is not normally a danger of damage to the system, however, when mouse communications are interrupted, often they fail to reinitialise when reconnected. Your AdderView Prism provides a feature to reinstate mouse communications once the necessary connections have been made.

There are two main types of data formats used by current PC mice, these are the older 'PS/2' format and the more recent 'IntelliMouse®' format introduced by Microsoft. These use slightly different data arrangements and it is important to know which type was being used before you hot-plugged the AdderView Prism. The previous setting depends both on the type of mouse and the type of driver as various combinations of PS/2 and Intellimouse are possible. Using the incorrect restore function may produce unpredictable results and require the system to be rebooted.

Which restore setting do I use?

The general rule is that unless both the mouse *and* the driver are *both* Intellimouse compatible then you need to restore the mouse as 'PS/2'.

Recognising an Intellimouse-style mouse

The Intellimouse format was introduced to support, among other features, the scroll wheel function. If your mouse has a scroll wheel, then it is likely to support the Intellimouse format. If you have a Microsoft mouse, then it will usually state that it is an Intellimouse on its underside label.







Note: Where a mixture of different mice are connected to the AdderView Prism, only one of the connected mice needs to be Intellimouse-style in order to consider using the Intellimouse restore command.



Recognising an Intellimouse driver

Before hot plugging your AdderView Prism (or afterwards using only keyboard control), access the Windows Control Panel and select either the *Mouse* option (on Windows NT, 2000 and XP) or the *System* option (on Windows 95, 98, ME). Look for the name of the driver, which will usually include the words *PS/2* or *Intellimouse*.

To restore mouse operation when hot plugging:

- 1 Carefully connect your AdderView Prism to the host system (or KVM switch) and to the keyboards, video monitors and mice.
- 2 Using any of the connected keyboards (it is only necessary to perform this operation once), enter the appropriate restore function code:

- *PS/2* – press   
- *IntelliMouse* – press   

(*Note:*   are the standard hotkeys which can be changed - see [Using configuration options](#) for details).

- 3 To exit configuration mode, press .
- 4 Move the mouse a short distance and check for appropriate onscreen cursor movement. If the mouse cursor darts erratically around the screen, then cease moving the mouse. This is an indication that the chosen restore function is incorrect. Try again using the other restore function.

Note: The restore functions predict the likely mouse resolution settings but may not restore the exact speed or sensitivity settings that were originally set.

AdderView Prism software upgrade

The internal software of your AdderView Prism can be upgraded to utilise the latest features and functionality.

To perform a software upgrade, you need to carry out the following stages:

- **Stage A** Download the upgrade file.
- **Stage B** Create a startup diskette and copy the files to it.
- **Stage C** Place the AdderView Prism in upgrade mode and reboot.

Stage A - Download the upgrade file

To download the files

- 1 Access the Adder Technology Ltd website (www.adder.com), enter the Support section. Choose the upgrade option that best suits your requirements and download it to your system.
- 2 Decompress the downloaded file. There should be the following files:
 - AUTOEXEC.BAT – directs the computer to run the driver update and firmware upgrade programs.
 - AVPxxx.EXE – this is the upgrade program that causes upgrade data to be sent to the AdderView Prism from your PC.
 - AVPxxx.HEX – this file contains the code to be downloaded into the AdderView Prism by the AVPxxx.exe program.
Where xxx is the upgrade version number.

Now please follow Stage B.



WELCOME

INSTALLATION
& OPERATION

SPECIAL
CONFIGURATION

FURTHER
INFORMATION

INDEX

Stage B - Create a startup diskette and copy files to it

For this stage you will need a 3½ floppy diskette that is either blank or has existing contents that are no longer required. The write protect tab must be moved to the 'unprotected' position. Depending on your operating system, use one of the following to create a startup disk:

To create a startup disk in Windows XP

- 1 Insert a diskette into the floppy disk drive.
- 2 Select 'Start' and then 'My Computer'.
- 3 Right mouse click on the '3½ Floppy (A:)' icon and select 'Format'.
- 4 Check the 'Create an MS-DOS startup disk' box and select 'Start'.

To create a startup disk in Windows 95/98/Me

- 1 Insert a formatted diskette into the floppy disk drive.
- 2 Select 'Start', then 'Settings' and then 'Control Panel'.
- 3 Double click on the 'Add/Remove Programs' icon.
- 4 Select the 'Startup Disk' tab.
- 5 Click 'Create Disk' and follow the instructions.

To create a startup disk in Windows 95/98 (alternative method)

- 1 Insert a diskette into the floppy disk drive.
- 2 Right mouse click on the '3½ Floppy (A:)' icon and select 'Format'.
- 3 Select the 'Full format' option and ensure that the 'Copy system files' box is checked.
- 4 Select 'Start' to format the disk.

To create a startup disk from MS-DOS or a DOS window within Windows 95/98

- 1 Insert a diskette into the floppy disk drive and check that the drive is configured as drive A (it usually is).
- 2 At the DOS prompt (C:\>) type:

```
FORMAT A: /S
```

and follow the instructions given by DOS.

Copy the upgrade files to the new startup diskette

- Using Windows Explorer or the My Computer option, copy the downloaded and decompressed files from your computer to the floppy diskette.

Now please follow Stage C.

Stage C - Place the AdderView Prism in upgrade mode and reboot

- 1 On the AdderView Prism front panel, click switch 7 down into its ON position to select upgrade mode at its next power on.
- 2 Restart the AdderView Prism in one of two ways, either:
 - Remove and replace the power supply connection, or
 - Briefly click AdderView Prism switch 3 down into its ON position and then back up to its OFF position.

The AdderView Prism will illuminate all of its front panel indicators to confirm that it is in upgrade mode.

- 3 On the computer that is connected to the AdderView Prism, ensure that its BIOS settings will allow it to boot from the floppy drive, rather than booting immediately from the hard drive.
- 4 Place the upgrade diskette installed in the floppy drive, switch off the computer and then power it up once again to allow it to boot from the floppy diskette and automatically perform the flash upgrade.

The upgrade process should take no more than two to three minutes and a progress indicator will be displayed on screen.

- 5 Once the upgrade is complete, click AdderView Prism switch 7 back to its OFF position.

The upgrade process is now complete. Do not forget to remove the floppy diskette from the computer's drive.



WELCOME

INSTALLATION
& OPERATION

SPECIAL
CONFIGURATION

FURTHER
INFORMATION

INDEX

Further information

This chapter contains a variety of information, including the following:

- Getting assistance - see opposite
- [Other products in the Adder range](#)
- [Warranty](#)
- [Safety information](#)
- [Radio frequency energy statements](#)

Getting assistance

If you are still experiencing problems after checking the list of solutions in the Troubleshooting section then we provide a number of other solutions:

- Adder Technology website – www.adder.com
Check the Support section of our website for the latest solutions and driver files.
- Email – support@adder.com
- Fax in the UK: **01954 780081**
 in the US: **+1 888 275 1117**
- Phone in the UK: **01954 780044**
 in the US: **+1 888 932 3337**



WELCOME

INSTALLATION
& OPERATION

SPECIAL
CONFIGURATION

FURTHER
INFORMATION

INDEX

Other products in the Adder range

The following complementary KVM switch devices are available:

- SmartView 4XPRO 16 port (part code: SV4X16)
- SmartView 2XPRO 8 port (part code: SV2X8)
- SmartView 2XPRO 4 port (part code: SV2X4)
- AdderView Matrix 208 (part code: AVM208)
- AdderView Matrix 216 (part code: AVM216)

Warranty

Adder Technology Ltd warrants that this product shall be free from defects in workmanship and materials for a period of two years from the date of original purchase. If the product should fail to operate correctly in normal use during the warranty period, Adder will replace or repair it free of charge. No liability can be accepted for damage due to misuse or circumstances outside Adder's control. Also, Adder will not be responsible for any loss, damage or injury arising directly or indirectly from the use of this product. Adder's total liability under the terms of this warranty shall in all circumstances be limited to the replacement value of this product.

If any difficulty is experienced in the installation or use of this product that you are unable to resolve, please contact your supplier.

Safety information

- For use in dry, oil free indoor environments only.
- Warning - live parts contained within power adapter.
- No user serviceable parts within power adapter - do not dismantle.
- Plug the power adapter into a socket outlet close to the module that it is powering.
- Replace the power adapter with a manufacturer approved type only.
- Do not use the power adapter if the power adapter case becomes damaged, cracked or broken or if you suspect that it is not operating properly.
- If you use a power extension cord with the AdderView Prism, make sure the total ampere rating of the devices plugged into the extension cord does not exceed the cord's ampere rating. Also, make sure that the total ampere rating of all the devices plugged into the wall outlet does not exceed the wall outlet's ampere rating.
- Do not attempt to service the AdderView Prism yourself.



WELCOME

INSTALLATION
& OPERATION

SPECIAL
CONFIGURATION

FURTHER
INFORMATION

INDEX

Radio Frequency Energy

All interface cables used with this equipment must be shielded in order to maintain compliance with radio frequency energy emission regulations and ensure a suitably high level of immunity to electromagnetic disturbances.

European EMC directive 89/336/EEC

This equipment has been tested and found to comply with the limits for a class A computing device in accordance with the specifications in the European standard EN55022. These limits are designed to provide reasonable protection against harmful interference. This equipment generates, uses and can radiate radio frequency energy and if not installed and used in accordance with the instructions may cause harmful interference to radio or television reception. However, there is no guarantee that harmful interference will not occur in a particular installation. If this equipment does cause interference to radio or television reception, which can be determined by turning the equipment on and off, the user is encouraged to correct the interference with one or more of the following measures: (a) Reorient or relocate the receiving antenna. (b) Increase the separation between the equipment and the receiver. (c) Connect the equipment to an outlet on a circuit different from that to which the receiver is connected. (d) Consult the supplier or an experienced radio/TV technician for help.

FCC Compliance Statement (United States)

This equipment generates, uses and can radiate radio frequency energy and if not installed and used properly, that is, in strict accordance with the manufacturer's instructions, may cause interference to radio communication. It has been tested and found to comply with the limits for a class A computing device in accordance with the specifications in Subpart J of part 15 of FCC rules, which are designed to provide reasonable protection against such interference when the equipment is operated in a commercial environment. Operation of this equipment in a residential area may cause interference, in which case the user at his own expense will be required to take whatever measures may be necessary to correct the interference. Changes or modifications not expressly approved by the manufacturer could void the user's authority to operate the equipment.

Canadian Department of Communications RFI statement

This equipment does not exceed the class A limits for radio noise emissions from digital apparatus set out in the radio interference regulations of the Canadian Department of Communications.

Le présent appareil numérique n'émet pas de bruits radioélectriques dépassant les limites applicables aux appareils numériques de la classe A prescrites dans le règlement sur le brouillage radioélectriques publié par le ministère des Communications du Canada.



WELCOME

INSTALLATION
& OPERATION

SPECIAL
CONFIGURATION

FURTHER
INFORMATION

INDEX

© 2004 Adder Technology Limited
All trademarks are acknowledged.
Release 1.0b
October 2004
Part No. ADD0054

Adder Technology Limited,
Technology House,
Trafalgar Way, Bar Hill,
Cambridge, CB3 8SQ,
United Kingdom
Tel: +44 (0)1954 780044
Fax: +44 (0)1954 780081

Adder Corporation,
29 Water Street,
Newburyport,
MA 01950,
United States of America
Tel: +1-888-932-3337
Fax: +1-888-275-1117

WELCOME

INSTALLATION
& OPERATION

SPECIAL
CONFIGURATION

FURTHER
INFORMATION

INDEX

Index



- A**
 - Arbitration
 - between users 9
- B**
 - Bandwidth 2
- C**
 - Cables
 - extension 5
 - Cable lengths 6
 - Checking
 - power requirements 8
 - Configuration
 - options 11
 - switches 10
 - Connecting
 - host computer 7
 - keyboard 7
 - mouse 7
 - power supply 8
 - video monitor 7
 - Connector
 - colours 7
- D**
 - Display Data Channel [DDC] 7
- E**
 - Extension cables 5
- F**
 - Features 4
- H**
 - Hotkey combinations
 - changing 11
 - Hot plugging 12
- I**
 - Indicators 9
 - Intellimouse 12
 - Items
 - available 5
 - included 5
- K**
 - KVM cables 5
- M**
 - Mounting 6
 - Mouse
 - restoration 12
 - speed timing 11
- P**
 - Power requirements 8
 - Power supply 8
- R**
 - Radio frequency energy 17
 - Resetting 9,10
 - Resource sharer 3
- S**
 - Safety information 16
 - SmartView XPRO 3
 - Square matrix 3
 - Switches
 - configuration 10
- U**
 - Upgrade
 - procedure 13
 - Upgrade mode 10
 - USB converter 5
- V**
 - Video boost 10
 - Video boost feature 9
 - Video resolutions 6
 - Video splitter 3
- W**
 - Warranty 16

WELCOME

INSTALLATION
& OPERATION

SPECIAL
CONFIGURATION

FURTHER
INFORMATION

INDEX