

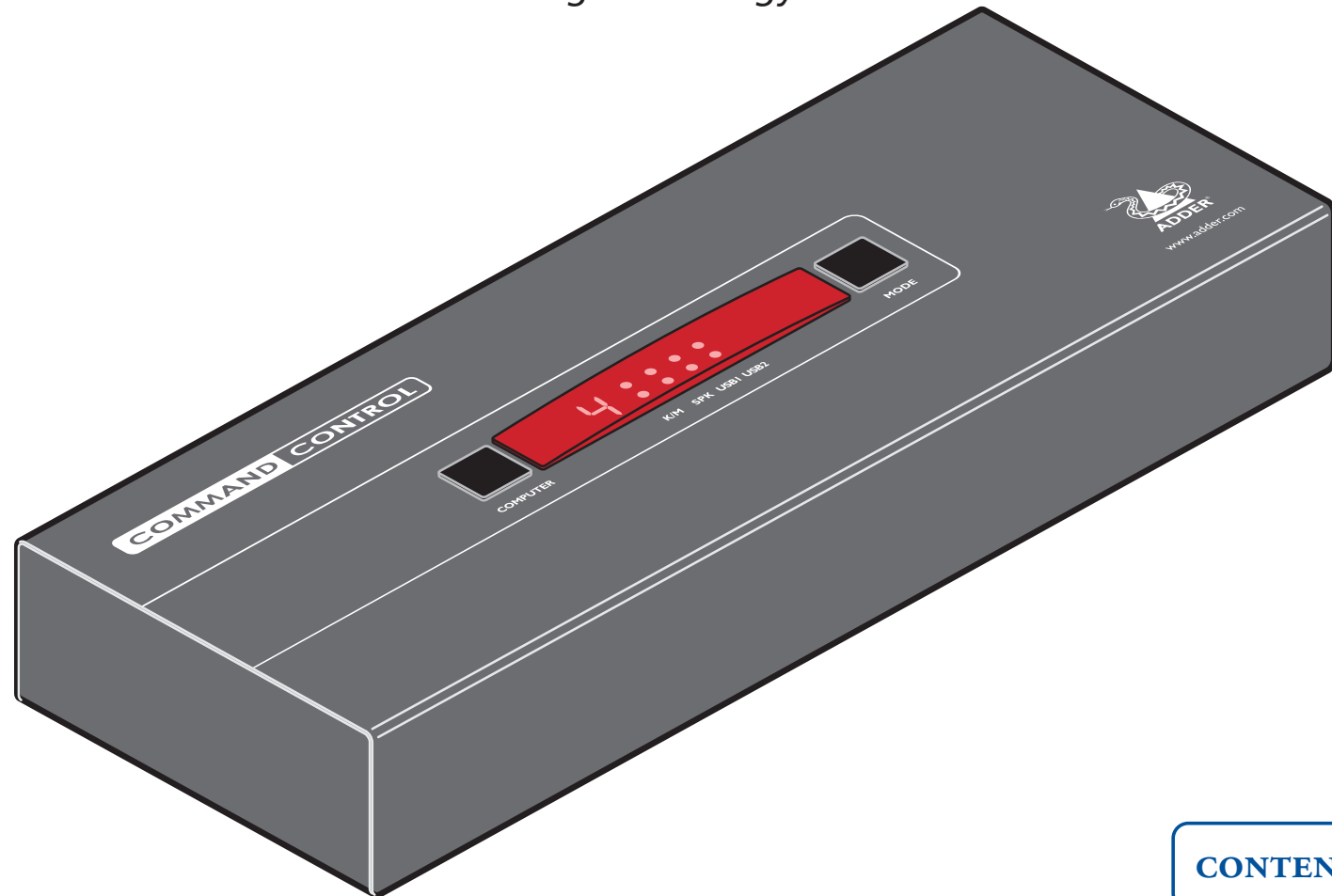

# CCS4-USB

## Four-port keyboard and mouse switch

*Now with Free-Flow switching technology*



CONTENTS

# Contents



## Welcome

Introduction .....	2
What is Free-Flow? .....	3
What is True Emulation? .....	4
CCS4-USB features - top and rear .....	5
What's in the box .....	6
What you may additionally need .....	6

## Installation

Locations .....	7
Mounting .....	7
Connections .....	8
User console .....	8
Computer systems .....	8
Power connection .....	9
Optional RC4 remote control .....	9
Switching control by computer .....	10

## Configuration

Using the configuration menu .....	11
General configuration .....	12
Changing hotkeys .....	12
Mouse switching .....	12
Miscellaneous functions .....	12
OPTIONS port speed .....	12
Free-Flow configuration .....	13
Installing the Free-Flow configuration application .....	13
Configuring the Free-Flow system .....	13
Optional Free-Flow operations and settings .....	14
Performing upgrades .....	15

## Operation

Selecting a computer .....	17
To select a computer using the Free-Flow utility .....	17
To select a computer using the control panel .....	17
To select a computer using hotkeys .....	18
To select a computer using the mouse buttons .....	19
To lock access to the computers .....	20

## Further information

Getting assistance .....	21
Appendix 1 – Cable pin-outs .....	22
Safety information .....	23
Warranty .....	23
Emissions and Immunity .....	24

WELCOME

INSTALLATION

CONFIGURATION

OPERATION

FURTHER INFORMATION

# Welcome



## Introduction

The CCS4-USB (Command and Control Switch, four port, USB) is a compact unit created to allow a single operator to access information and control operations across numerous systems and screens. With the CCS4-USB unit, you can use a single USB keyboard and USB mouse to fulfil functions that previously required four separate sets. This provides immediate savings in both desk space and also the time required to access and control up to four systems and screens. The CCS4-USB features our [True Emulation](#) technology, which ensures that the full characteristics of the connected USB keyboard and mouse are passed to every system.

In addition to switching the keyboard and mouse, the CCS4-USB can also share a set of speakers and two separate USB peripherals between the four systems. This can be done either in concert with the keyboard and mouse (and each other) or totally independently.

The CCS4-USB unit can be used in combination with various Adder extender products (such as Adder Infinity, X50 and X-USB) to extend the distance between the user and the computers under control.

Switching between the systems connected to the CCS4-USB can be achieved in five different ways:

- The innovative [Free-Flow](#) automatic switching utility,
- The COMPUTER button on the top panel,
- Keyboard hotkey combinations,
- Mouse button combinations,
- The optional remote control selector.

The video displays are connected directly to their respective systems as usual. A single USB link (plus an optional speaker connection) is made between each system and the CCS4-USB unit.

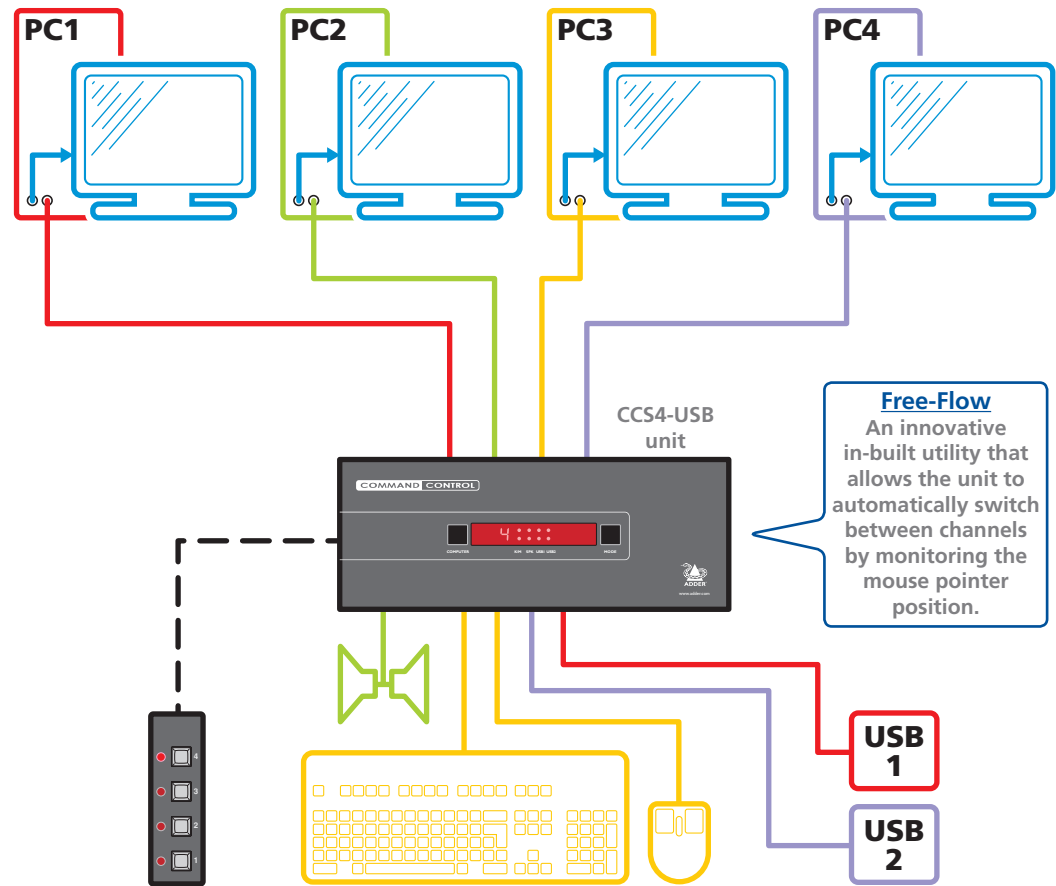

The optional remote control allows the CCS4-USB unit to be neatly concealed amongst the cabling.

The keyboard/mouse, the speakers and two individual USB channels can be collectively or separately switched through to each PC system. These are electronically switched to the required system using any of five methods: Free-Flow utility, CCS4-USB unit control panel, keyboard key-presses, mouse buttons or optional remote control.

WELCOME

INSTALLATION

CONFIGURATION

OPERATION

FURTHER INFORMATION

# What is Free-Flow?

The Adder Free-Flow represents true innovation in KVM switching. For the first time, Free-Flow allows users to automatically switch between target computers simply by moving the mouse pointer from screen to screen. What makes this such a revolution is that you no longer need software to be installed on your mission critical computers in order to do this. Adder Free-Flow resides on the switch itself, sensing screen boundaries and instantaneously switching keyboard and mouse to the defined target computer. Free-Flow can be configured for almost any combination of screens using the included application which allows you to declare the individual screen sizes and visually position each one relative to the others.

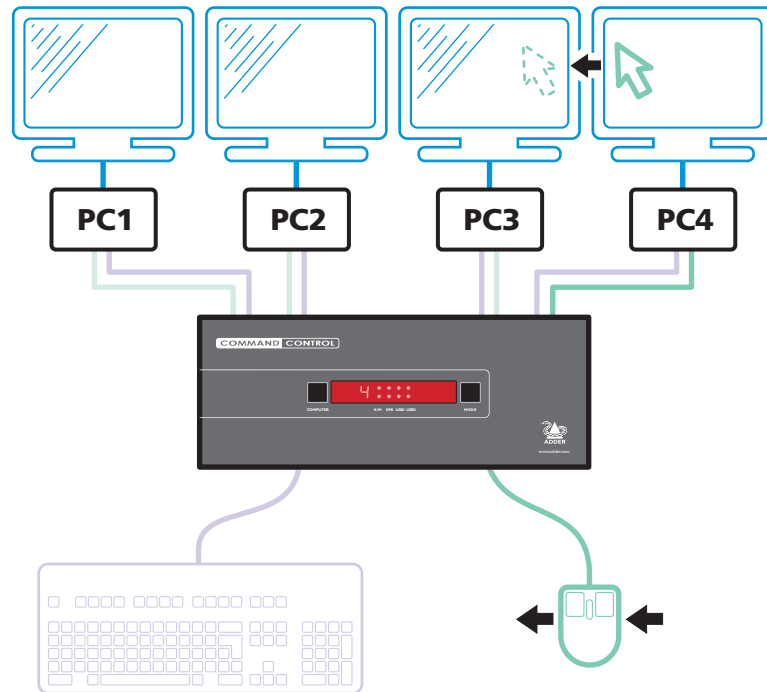

Free-Flow consists of special code within the CCS4-USB unit plus an intuitive graphical configuration application. First you inform the Free-Flow configuration application how many screens you have, their pixel resolutions and how they are physically arranged (e.g side-by-side, vertical stack, square formation, etc.). You then download this information to the CCS4-USB unit and this is used during operation to determine the precise moment to switch from one screen/system to the next.

The beauty of Free-Flow is its simplicity of configuration and operation. Once the initial configuration has taken place, all monitoring and switching is handled within the CCS4-USB without need for extra connections or software utilities.

## Issues when using Free-Flow

- The CCS4-USB unit must have a minimum of firmware version 1.50 installed to operate with Free-Flow.
- Free-Flow does not run any special utilities on each computer and thus has no way to instruct the computers to hide their mouse pointers when they are deselected by the CCS4-USB unit. Therefore, the CCS4-USB 'parks' each mouse pointer in the bottom right corner of the screen immediately before changing the channel. In most cases this will cause no issues, however, it may be noticeable in circumstances such as the following:
  - If the task bar is set to auto hide and it is positioned either along the bottom of the screen (as default) or along the right hand side, then the task bar will automatically reappear when the mouse pointer is parked.
  - When playing full screen video, the on-screen controls (play, pause, seek etc.) will very likely be revealed when the mouse pointer is parked.
- The mouse will not flow across the screens while any mouse buttons are pressed down - this prevents undesired behaviour when dragging windows around or group-selecting items.

## More information

- [Free-Flow Configuration](#)
- [Operation: Selecting a computer](#)

# What is True Emulation?

True Emulation represents a significant breakthrough in sharing USB devices between two or more computer systems. Until this point, the problem has been how to create a USB switch that provides all of the following:

- Quick, transparent and reliable switching,
- Accurate representation of the connected USB keyboard and mouse,
- Switching control via the connected USB keyboard and/or mouse.

The difficulty in achieving all of the above requirements has been due to the complexity of the USB standard. This has led to various problems that have spawned a number of possible solutions.

## Enumerated USB switching

The earliest attempts to switch USB devices applied a relatively 'hands off' approach. Enumerated USB switches are the electronic equivalent of those old mechanical KVM switches with a large knob on the front.

Enumerated switches are so called because a connected USB device will be required to perform a full initiation (a process called *Enumeration*) every time it is switched; just as if you had pulled out the plug and then reconnected it.

Enumerated switches simply pass all signals straight through between the USB device and the computer, they do not attempt to interpret any data. For most devices, this offers an advantage because the switch just leaves them to get on with their jobs without any interference or any hit on performance. However, it means that a USB keyboard or mouse cannot be used to control the switching process - a quick and simple control method expected by most users. Reliability of switching is also an issue that has plagued enumerated switches, especially when used with certain USB devices and particular operating systems.

## Emulated USB switching

The issues with interpreting the complex USB data streams and recreating (or *Emulating*) the identity of attached USB devices were eventually solved, leading to the creation of the Emulated USB switch.

A neat side effect of the technique used is that each computer can be fooled into thinking that the USB device is permanently connected to it, even when the device is switched to another computer. This means that the enumeration process for the USB device takes place only once, during the first power on. After that, a computer merely sees a dormant version of the USB device whenever the device is actually connected to a different computer.

However, it remains a complex task to dynamically assume the identity of a USB device, distribute it among the connected computers and maintain all of the necessary signals, states and processes. Therefore, manufacturers have previously relied upon a fixed keyboard and mouse profile that is declared to each computer, regardless of the actual connected devices. This precluded the use of any special keyboard or mouse features over and above the standard layouts.

## True Emulation

Mindful of the limitations associated with the previous USB switching techniques, we set about creating a more effective and elegant solution. After a great deal of research and development, *True Emulation* is the result.

True Emulation allows the complete identity of the keyboard and mouse to be copied and then presented to all of the connected computers. This means that any keyboard offering specialist function keys or any mouse with extra features will be fully supported at each computer. As with the previous emulation method, the unselected computers will continue to see the identities of the keyboard and mouse, which means that no enumeration is necessary when their link becomes active once again. This not only helps to speed up the rate of reconnection, but also raises the reliability of switching because USB links are at their most vulnerable during the enumeration process.

True Emulation relies upon a high speed circuit, called an Emulation Engine, to fully emulate the USB device identities and also interpret keyboard and mouse data streams. The result is full support for KVM switching control via hotkey presses or the third button/scroll wheel of a mouse.

True Emulation is not necessarily required by other USB devices, which is why you will also find two enumerated circuits included (shown in green within the block diagram) alongside the True Emulation feature (shown in blue). This allows those other USB devices to operate at their highest speeds, without any intervention. The enumerated circuits benefit greatly from the USB Hubs that are jointly used with the True Emulation system. Because they interface directly and permanently with each computer, they help to stabilise the dormant links, making errors during enumeration much less likely.

The dual switching arrangement provides further flexibility because the True Emulation and enumerated sections can be switched in unison or independently of each other, as required. Thus, your various peripherals can operate with different computers at the same time.

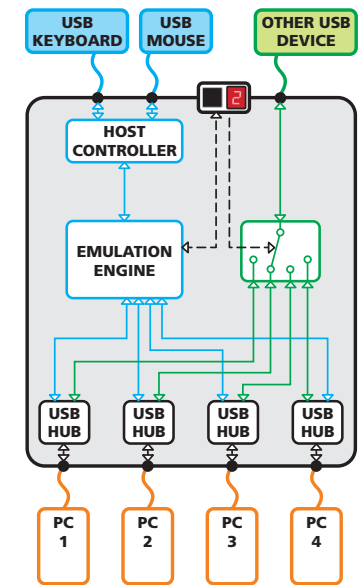

The emulated section of the switch is shown in blue and handles only the keyboard and mouse. The green enumerated section of the switch handles other USB devices and also uses the USB hubs to link with the computers.



- WELCOME
- INSTALLATION
- CONFIGURATION
- OPERATION
- FURTHER INFORMATION

# CCS4-USB features - top and rear

The CCS4-USB unit is housed within durable, metallic enclosure with all connectors situated at the rear panel. The smart top panel features the control buttons and the operation indicators.

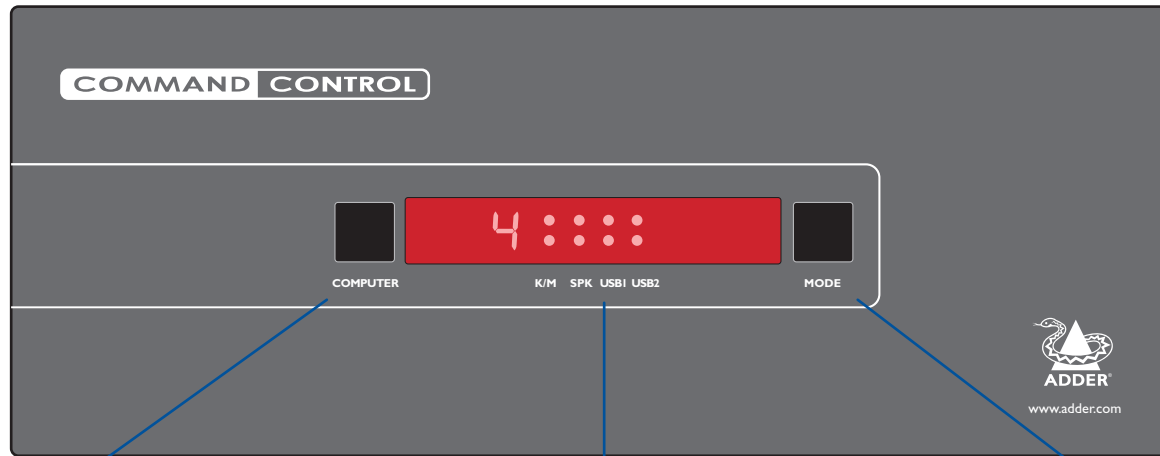

**COMPUTER button**  
Press to change to the next computer channel.

**Indicators**

The upper four indicators scroll across in sequence when the [Free-Flow](#) utility is engaged. The lower four indicators (**K/M**, **SPK**, **USB1**, **USB2**) show which peripherals are switched to the current computer channel OR (as you begin pressing the MODE button) the peripherals that will be switched during the next press(es) of the COMPUTER button. The seven segment numeric display indicates the computer channel that is currently active.

**MODE button**  
Press to determine which peripherals should be switched to another computer channel (will occur when the COMPUTER button is pressed).

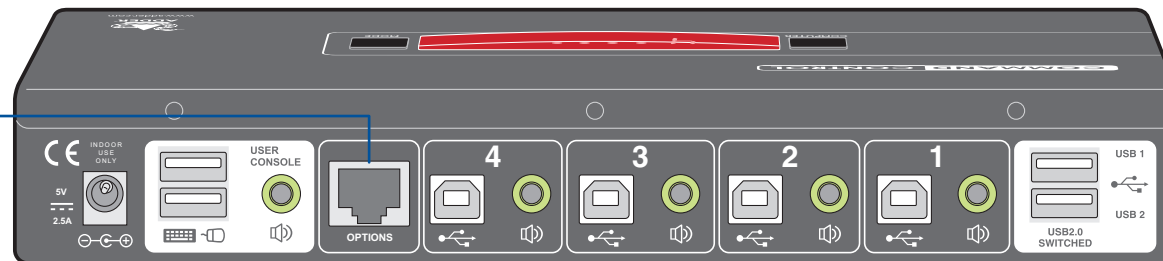

**Options port**

This 10p10c port can separately support the following functions:

- Remote control - allows a standard Adder RC4 four button remote control unit to be used to switch channels (see [Optional RC4 remote control](#) for details).
- Upgrades - used to update the internal firmware when necessary by connecting to a computer.

**Power input**  
The power supply connects here.

**User console**  
Connect a USB keyboard and mouse plus optional speakers to these connectors.

**Computer channels**  
Each computer connects to one of these four channels via a USB B-type connector and an audio 3.5mm jack input.

**User console**  
Connect up to two USB devices to these connectors. These ports are switched in an enumerated manner (see [What is True Emulation?](#))

- WELCOME
- INSTALLATION
- CONFIGURATION
- OPERATION
- FURTHER INFORMATION

# What's in the box

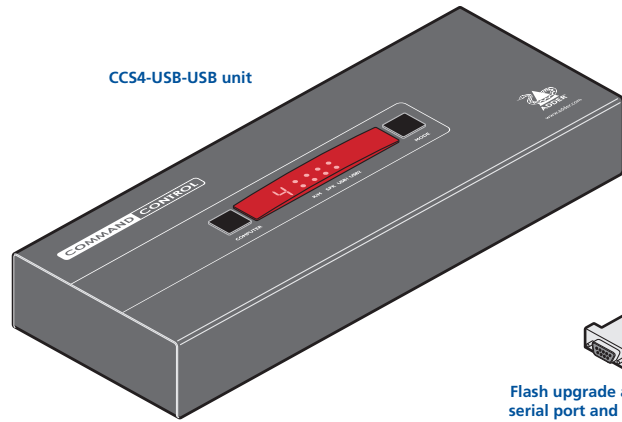

CC54-USB-USB unit

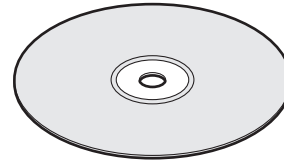

CD-ROM

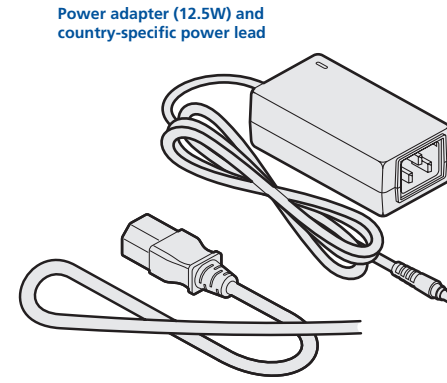

Power adapter (12.5W) and country-specific power lead

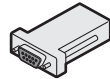

Flash upgrade adaptor - requires serial port and a CAT5 patch lead



Four self-adhesive rubber feet

# What you may additionally need

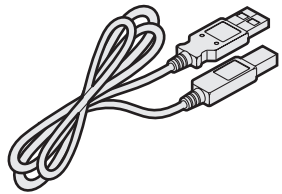

USB cable 2m (type A to B)  
Part number: VSC24

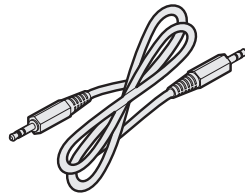

Audio cable 2m (3.5mm stereo jacks)  
Part number: VSC22

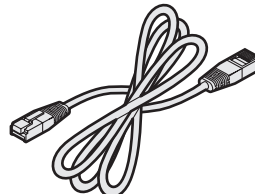

Standard 3m CAT5 patch lead  
Part number: VSC23

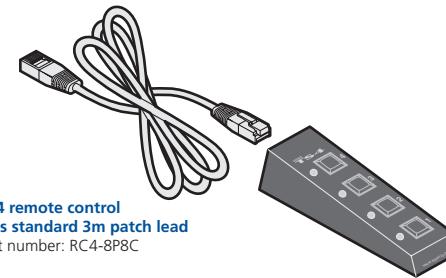

RC4 remote control plus standard 3m patch lead  
Part number: RC4-8P8C

WELCOME

INSTALLATION

CONFIGURATION

OPERATION

FURTHER INFORMATION

# Installation



## Locations

Please consider the following important points when planning the position of the CCS4-USB unit:

- Situate the CCS4-USB unit close to the systems to which it will be connected and near to a source of mains power.
- Thanks to the optional remote control, the CCS4-USB unit can be situated out of sight within the cabling cradle of a desk or placed adjacent to the connected systems.
- Consult the precautions listed within the [Safety information](#) section.

## Mounting

Before you begin connecting to the keyboard, mouse and source systems, it is advisable to mount the CCS4-USB unit in place, either:

- On a horizontal surface using the supplied self adhesive feet, or
- Amongst the cabling at the rear of the desk.

WELCOME

INSTALLATION

CONFIGURATION

OPERATION

FURTHER  
INFORMATION

# Connections

Connections do not need to be carried out in the order given within this guide, however, where possible connect the *power in* as a final step

## User console

The ports that make up the user console are where you attach the peripherals which will be shared between the computer systems. Ensure that power is disconnected from the unit.

### To connect peripherals to the user console

- 1 Position your peripheral devices in the vicinity of the unit such that their cables will easily reach.
- 2 **Keyboard and mouse:** Attach the leads from your USB keyboard and mouse to the USB sockets specifically labelled with keyboard and mouse symbols. The keyboard and mouse will operate in any of the USB sockets, however, [True Emulation](#) is not available on sockets labelled USB1 or USB2.

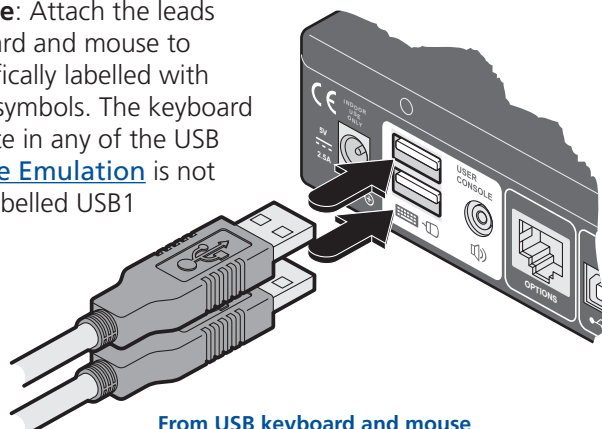

- 3 **USB devices:** Where required, attach the leads from your USB peripherals to the USB sockets labelled USB1 and USB2.

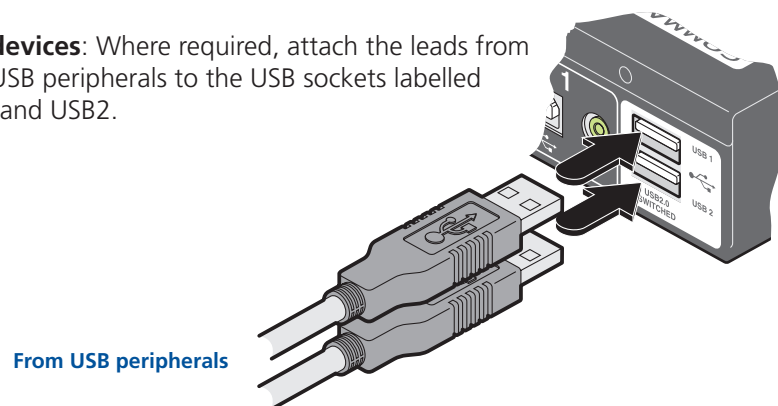

- 4 **Audio:** Where required, connect the lead from your speakers to the audio socket.

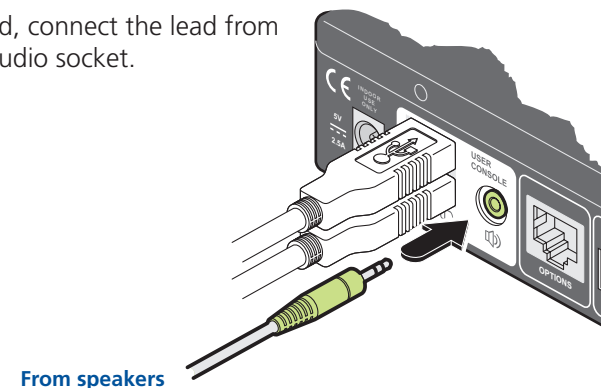

## Computer systems

Each computer system is connected to the CCS4-USB unit using (up to) two cables.

### To connect a computer system

- 1 Ensure that power is disconnected from the CCS4-USB unit and the system to be connected.
- 2 Use a USB cable (type-A to type-B) to link a USB port on the computer system to the USB port of the required channel on the rear of the unit.
- 3 If required, use a stereo audio link cable (3.5mm jacks at either end) to link the speaker port on the computer system to the audio port of the required channel on the rear of the unit.

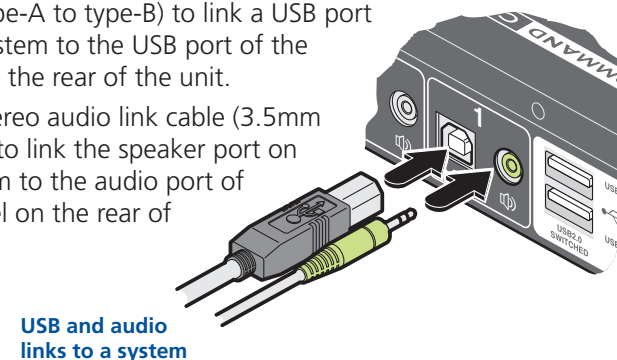

## Power connection

The CCS4-USB unit is supplied with a 12.5W power adapter. There is no on/off switch on the unit, so operation begins as soon as a power adapter is connected.

### To connect the power supply

- 1 Attach the output lead from the power adapter to the 5V socket on the rear panel of the unit.

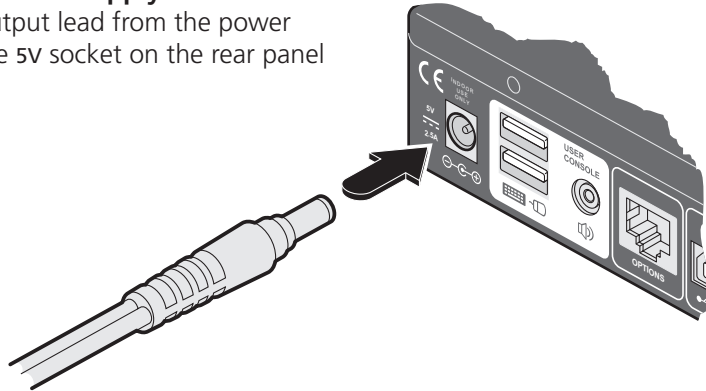

- 2 Connect the IEC connector of the supplied country-specific power lead to the socket of the power adapter.

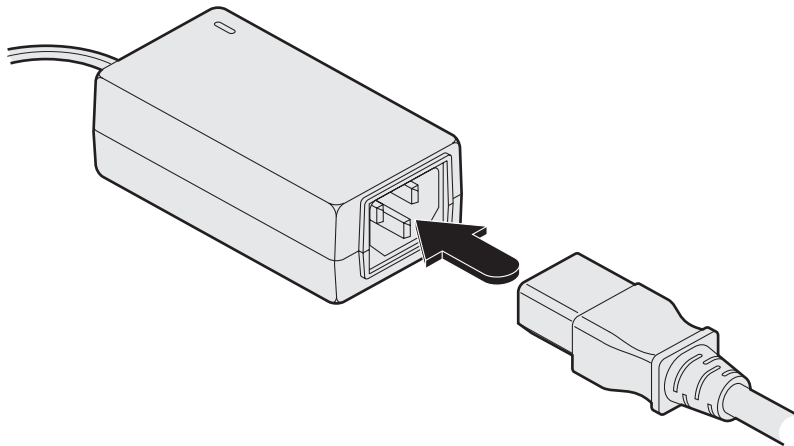

- 3 Connect the power lead to a nearby main supply socket.

*Note: Both the unit and its power supply generate heat when in operation and will become warm to the touch. Do not enclose them or place them in locations where air cannot circulate to cool the equipment. Do not operate the equipment in ambient temperatures exceeding 40 degrees Centigrade. Do not place the products in contact with equipment whose surface temperature exceeds 40 degrees Centigrade.*

## Optional RC4 remote control

The optional RC4 remote control unit (full part number: RC4-8P8C) can be used to provide direct push button access to any channel from your desktop. The RC4 remote control is supplied with a 3 metre cable that is used to link with the OPTIONS port on the rear panel of the unit.

### To connect the remote control

- 1 Connect either end of the supplied cable to the socket at the rear of the RC4 remote control.

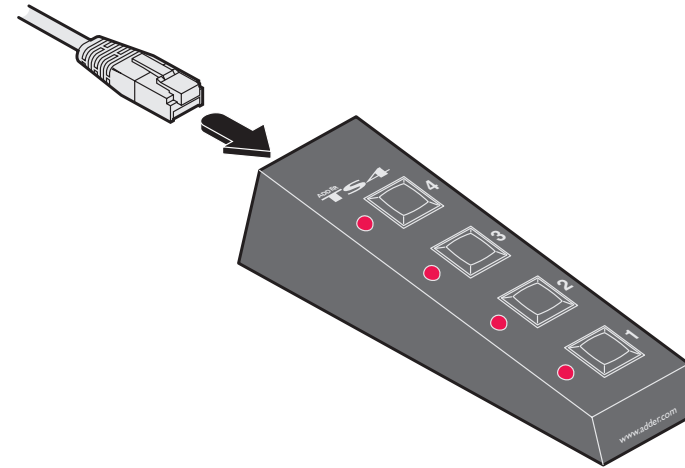

- 2 Connect the other end of the cable to the OPTIONS port on the rear panel of the unit.

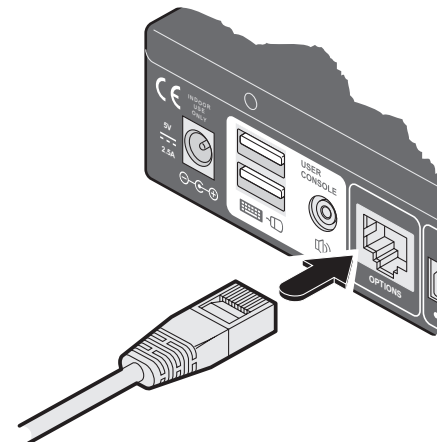

## Switching control by computer

The **OPTIONS** port allows an external serial input, typically from a computer, to control the selection of the various channels. You can use either the supplied Flash Upgrade Adaptor plus a standard CAT5 patch cable (part number VSC23) or alternatively construct a custom cable to link the CCS4-USB unit and the computer. For pin-out details of the custom cable, see [Appendix 1](#).

Upon receipt of the correct code, the CCS4-USB will switch immediately to the appropriate channel.

### Connecting a computer for remote control

The cable link from the computer needs to connect the transmit (TXD) line of the computer to the receive (RXD) input of the CCS4-USB and also link the ground terminals (GND) of the two devices. See [Appendix 1](#) for details.

#### To connect a computer remote control

- 1 Use either the supplied Flash Upgrade Adaptor plus a standard CAT5 patch cable or alternatively a custom cable to link the **OPTIONS** port on the rear panel of the CCS4-USB unit and a vacant serial port on the computer.

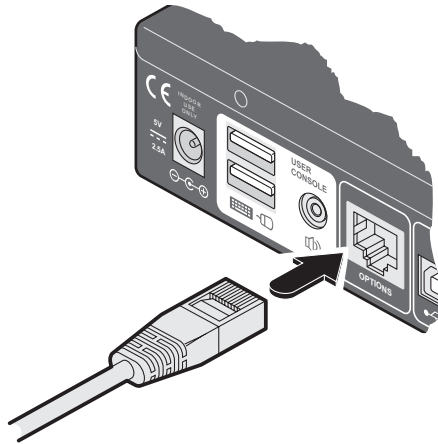

### Serial port parameter settings

Ensure that the chosen serial port is configured to the following:

- Baud rate: 1200
- Data bits: 8
- Stop bit: 1
- Parity: None

### Channel selection codes

	ASCII Character	Hex	Decimal
• Channel 1:	'1'	0x31	49
• Channel 2:	'2'	0x32	50
• Channel 3:	'3'	0x33	51
• Channel 4:	'4'	0x34	52

# Configuration

## Using the configuration menu

The configuration mode allows you to determine numerous aspects of the CCS4-USB unit capabilities.

### To use the configuration menu

During normal use, the seven segment display on the control panel shows the number of the currently selected computer channel. From this condition, enter configuration mode as follows:

- 1 Press and hold the control panel **COMPUTER** button for roughly five seconds.  
*The display will show: [*
- 2 On the keyboard, press the letter key for the required menu section, e.g. **S**  
*The display will show the pressed letter, e.g. **S***
- 3 Press the number of the required setting, e.g. **4**  
*The display will show the pressed number, e.g. **4***
- 4 Press **Enter** to accept the setting and return to the main menu section.  
*The display will show: [*
- 5 You can now continue with your next configuration change (go to step 2), or exit from the configuration menu (see below).

### To exit the configuration menu and save changes

- Press **E** and then press **Enter** to exit and save changes.

### To exit the configuration menu without saving

- Press either of the front panel buttons.

#### **B** Set the **OPTIONS** port baud rate

- 1 1200
- 2 2400
- 3 9600
- 4 19200
- 5 38400
- 6 57600
- 7 115200

You can press **Esc** at any point to exit from an option and return to the main menu ( **[** ) section.

#### **F** Enter the **Functions** menu

- 1 Show current firmware version
- 8 Reset configuration to factory defaults (**r** is displayed momentarily)

#### **H** Enter the **Hotkey** menu

- 1 Ctrl + Alt
- 2 Ctrl + Shift
- 3 Alt + Shift
- 4 Right Alt
- 5 Alt
- 6 Left Ctrl + Alt
- 7 Right Ctrl + Alt
- 8 Hotkeys disabled

#### **P** Set a new password for use with the lock mode

#### **S** Enter the **Switch Mode** menu

- 1 All
- 2 KVM + Speaker
- 3 KVM only
- 4 Speaker only
- 5 USB1 only
- 6 USB2 only

#### **U** Enter the **User Preferences** menu

- 1 Enable mouse switching
- 2 Disable mouse switching
- 7 Cycle all ports (when using 'Hotkey + Tab' or 'Autoscan')
- 8 Cycle only active ports (when using 'Hotkey + Tab' or 'Autoscan')



WELCOME

INSTALLATION

CONFIGURATION

OPERATION

FURTHER INFORMATION

# General configuration

## Changing hotkeys

CCS4-USB units use **Ctrl** and **Alt** as their standard hotkeys. These can be changed if they clash with other software or hardware within the installation.

### To change the hotkeys

- 1 Enter the [Configuration](#) menu.
- 2 Press **H** to enter the **Hotkey** menu and then press either:
  - 1** to choose **Ctrl + Alt**
  - 2** to choose **Ctrl + Shift**
  - 3** to choose **Alt + Shift**
  - 4** to choose **Right Alt**
  - 5** to choose **Alt**
  - 6** to choose **Left Ctrl + Alt**
  - 7** to choose **Right Ctrl + Alt**
  - 8** to disable the Hotkeys
- 3 Press **Enter** to accept the setting and return to the main menu section.
- 4 Press **E** and then **Enter** to exit the menu and save changes.

## Mouse switching

You can enable or disable mouse switching to suit your installation requirements.

### To enable/disable mouse switching

- 1 Enter the [Configuration](#) menu.
- 2 Press **U** to enter the **User Preferences** menu and then press either:
  - 1** to **Enable mouse switching**
  - 2** to **Disable mouse switching**
- 3 Press **Enter** to accept the setting and return to the main menu section.
- 4 Press **E** and then **Enter** to exit the menu and save changes.

## OPTIONS port speed

You can change the speed of the OPTIONS serial port.

### To change the OPTIONS port speed

- 1 Enter the [Configuration](#) menu.
- 2 Press **B** to enter the **Hotkey** menu and then press either:
  - 1** to choose **1200**
  - 2** to choose **2400**
  - 3** to choose **9600**
  - 4** to choose **19200**
  - 5** to choose **38400**
  - 6** to choose **57600**
  - 7** to choose **115200**
- 3 Press **Enter** to accept the setting and return to the main menu section.
- 4 Press **E** and then **Enter** to exit the menu and save changes.

## Miscellaneous functions

### To reset configuration to factory defaults

- 1 Enter the [Configuration](#) menu.
- 2 Press **F** to enter the **Functions** menu
- 3 Press **8** and then **Enter**. The display will show **r** momentarily.
- 4 Press **E** and then **Enter** to exit the menu and save changes.

### To show the current firmware version

- 1 Enter the [Configuration](#) menu.
- 2 Press **F** to enter the **Functions** menu
- 3 Press **1** and then **Enter**.  
The display will blank for a short while and then the major number of the firmware revision will be shown. The display will blank again and then show the first digit of the minor number. Following another blank, the second digit of the minor number will be displayed. e.g. *<blank> 1 <blank> 0 <blank> 2 <blank> equals v1.02*
- 4 Press **E** and then **Enter** to exit the menu and save changes.

### To set a new password

- 1 Enter the [Configuration](#) menu.
- 2 Press **P** and then **Enter**. The display will show **:**
- 3 Enter a new password and then **Enter**. See [To lock access to the computers](#).
- 4 Press **E** and then **Enter** to exit the menu and save changes.



# Free-Flow configuration

## Installing the Free-Flow configuration application

The Free-Flow configuration application is supplied on the enclosed CD-ROM and is also available for download from the Adder website ([www.adder.com](http://www.adder.com)).

- 1 Install the application onto any computer (not necessarily one of the four computers linked to the CCS4-USB unit) that has a vacant serial port. Run the installation application and follow the on-screen instructions.
- 2 Use the supplied Flash Upgrade Adaptor and a patch cable (VSC23 or any CAT5 patch cable) to link the computer serial port to the CCS4-USB OPTIONS port.
- 3 Start the configuration application.

## Configuring the Free-Flow system

Use the Free-Flow configuration application to declare the display screens and their positions relative to each other. Then download the configuration to the CCS4-USB unit.

- 1 On the icon bar, click the red, green, blue and yellow screen icons (or use the **Screens** menu) to add the required number of display screens to the map area.

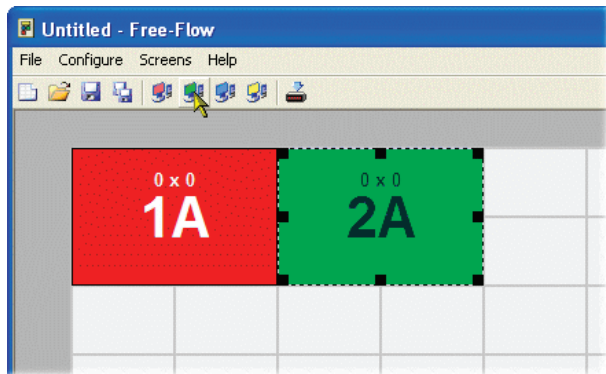

- 2 Arrange the coloured rectangular screen representations to mimic the physical layout of the actual displays, for example:



The important thing is to define where each screen edge abuts to the next so that the CCS-USB unit can determine the correct moments to switch channels. Use the small black squares around the perimeter of each highlighted screen representation to change their size or stretch them.

*Note: The numbering of the screen representations relate directly to the four channels on the CCS4-USB unit.*

- 3 Double-click on each screen representation to set the screen resolution and, optionally, to add a screen name. The screen resolutions are not critical but they enable the CCS4-USB unit to accurately map the movement of the mouse onto corresponding movements of the pointer across the screens. The screen names, if used, are not downloaded to the CCS4-USB unit.

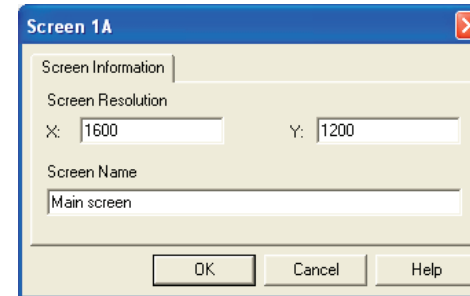

- 4 When the screen map is complete and accurately matches the true layout of the display screens, click **File** and choose the **Save** option to store a copy of the layout. The layout will be stored as a 'Free-Flow Config file' with the extension: **.ffc**
- 5 Ensure that the optional upgrade cable is correctly installed - see 'Installing the Free-Flow configuration application' left. Click the **Configure** menu and choose the **Connection...** option to ensure that the correct computer serial port is selected and that the Baud Rate matches that of the CCS4-USB unit (1200 is the default speed).
- 6 To send the configuration, click the **Send Layout to Switch** option.
  - If the download is successful, the upper four indicators on the CCS4-USB unit will begin to scroll across (they will continue to do this while Free-Flow mode is enabled).
  - If the download is unsuccessful, a message dialog will explain that it is 'Unable to communicate with the device'. Check the upgrade cable, check that the correct serial port is selected and check that the connection speed shown within the utility matches the speed used on the CCS4-USB unit.

See next page for [Optional Free-Flow operations and settings](#)

## Optional Free-Flow operations and settings

### Downloading the existing layout from the CCS4-USB.

If the CCS4-USB unit has already been configured and you wish to alter it (and you don't have a saved .ffc config file), use the **Configure > Receive Layout from Switch** option to retrieve the current configuration from the CCS4-USB.

### Mouse... setting

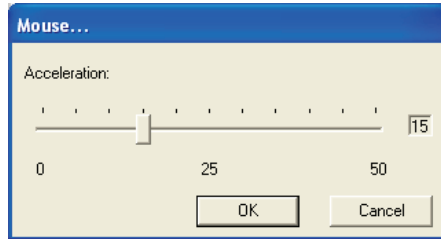

#### Mouse acceleration

Mouse acceleration allows you to move the mouse pointer quickly across the large areas of the screen in response to small but sharp shifts in the mouse position. The **Configure > Mouse...** option provides settings between 0 and 50, however, a value of 12 to 15 will give a typical Windows-like default operation.

### Switch... settings

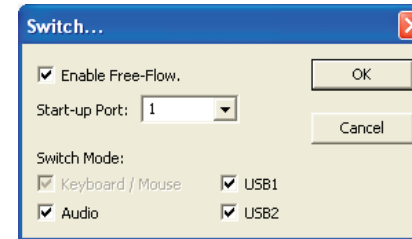

#### Enable (Disable) Free-Flow

This option allows you to switch off the Free-Flow feature within the CCS4-USB unit. Located within **Configure > Switch...** menu item, untick the **Enable Free-Flow** checkbox and download the configuration the CCS4-USB unit to disable.

#### Start-up Port

Located within **Configure > Switch...** menu item (see above image), this option allows you to determine which port should be enabled whenever the CCS4-USB unit is first powered on.

#### Switch Mode

Located within **Configure > Switch...** menu item (see above image), these check boxes allow you to determine which peripherals should be switched whenever the channel is changed by the Free-Flow method. The switching of peripherals via the other methods of channels selection (e.g. the front panel, hotkeys, mouse buttons, etc.) remain unaffected by these settings. By default, the Keyboard/Mouse and Audio are selected.

# Performing upgrades

The CCS4-USB unit is fully upgradeable via flash upgrade. Such upgrades require a Windows-based computer system to be linked via the **OPTIONS** port.

### Items required to perform an upgrade

- The supplied Flash Upgrade Adaptor plus an optional CAT5 patch cable (either Adder part number VSC23 or any standard CAT5 patch cable).
- A Windows-based computer with an RS232 serial port.
- The latest version of the KVM Firmware Uploader and firmware files for the CCS4-USB unit - available from the *Technical Support > Updates* section of the Adder Technology website ([www.adder.com](http://www.adder.com)).

### To use the KVM Firmware Uploader utility

#### 1 - Obtain and run the KVM Firmware Uploader.

Download the latest CCS4-USB unit KVM Firmware Uploader from the Adder Technology website and install it on a Windows-based upgrade computer that will be connected to the CCS4-USB unit. The files are supplied as a compressed ZIP file. Decompress the ZIP file with an appropriate tool such as WinZip ([www.winzip.com](http://www.winzip.com)) and copy all contained files to the same folder on the upgrade computer.

#### 2 - Power off the CCS4-USB unit

Remove the power supply plug from the rear panel of the unit.

#### 3 - Connect the upgrade computer to the CCS4-USB unit

Connect the supplied Flash Upgrade Adaptor to the serial port of the Windows-based computer and then link a patch cable (VSC23 or any standard CAT5 patch cable) between the adaptor and the **OPTIONS** port on the rear panel of the unit.

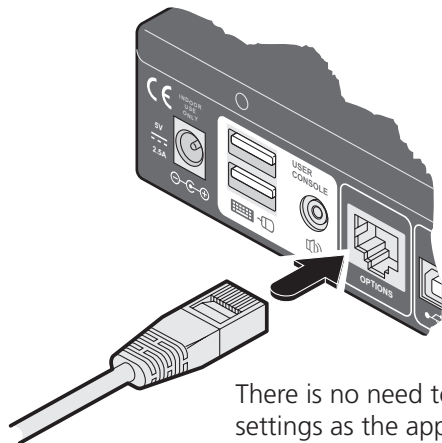

There is no need to adjust the computer's serial port settings as the application will do this automatically.

#### 4 - Invoke upgrade mode

While powering on or when already powered: Press and hold the **COMPUTER** and **MODE** buttons (for up to ten seconds) until the numeric indicator shows '**U**'.

#### 5 - Run the KVM Firmware Uploader utility

From that folder, select the KVMUploader icon to run the upgrade utility. The KVM Firmware Uploader dialog will be displayed:

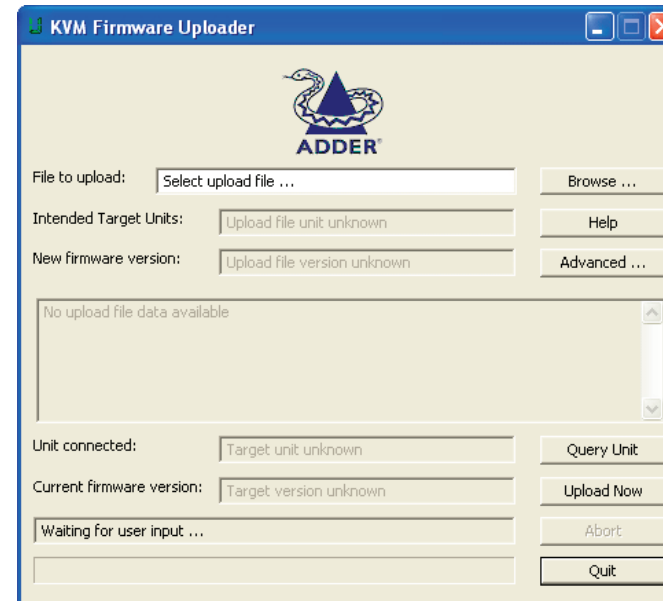

#### 6 - Query the CCS4-USB unit

Click the *Query Unit* button to confirm that communication is possible with the CCS4-USB unit and to establish its firmware details. If successful, the 'Unit connected' field should show the name of the CCS4-USB unit and the current firmware will also be listed.

If the application cannot contact the CCS4-USB unit, re-check the connection cable and click the *Advanced...* button to check that the correct serial port is being used. Change the serial port within the *Advanced...* section, if necessary.

*continued*



WELCOME

INSTALLATION

CONFIGURATION

OPERATION

FURTHER INFORMATION

### 7 - Select the upgrade file to be used

From the main KVM Firmware Uploader dialog, click the *Browse...* button and select the upgrade file:

CCS4U\_xxx.txt

where xxx is the firmware version.

The upgrade file details will be displayed within the dialog.

**IMPORTANT:** Check that the 'Intended Target Units' field matches the 'Unit Connected' field. If these fields do not match then you may have an incorrect upgrade file, check with Adder Technology Ltd before proceeding. Check also that the 'New firmware version' is greater than the 'Current firmware version'.

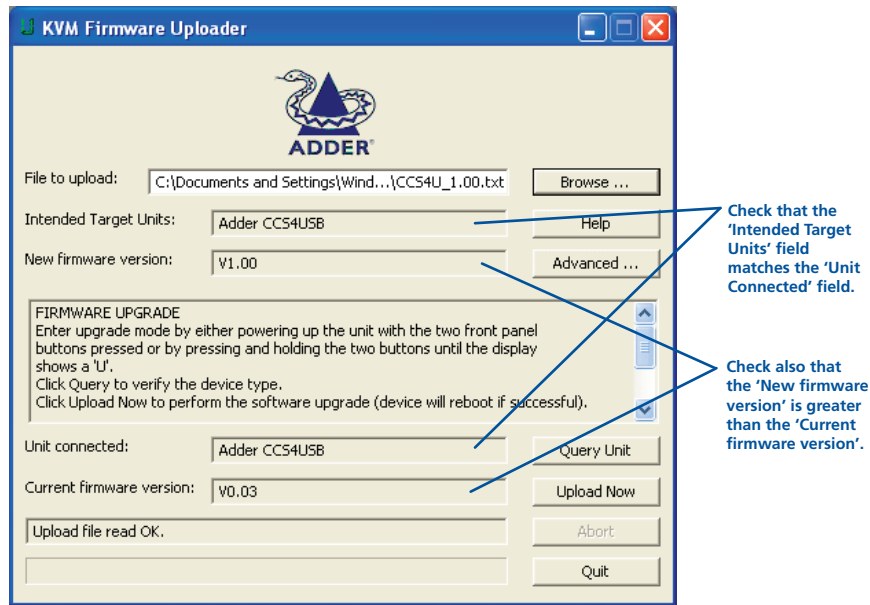

### 8 - Commence the upgrade

To begin the upgrade process, click the *Upload Now* button. The progress will be shown within the dialog. Should you decide not to continue with the upload at any stage, click the *Abort* button; response to this is usually immediate, however, during an erase command, the upload will not be aborted until the erase is complete (this may take a few seconds).

### 9 - Cycle the power

Disconnect the power and remove the upgrade cable. When the power is re-applied the CCS4-USB unit will operate using the new firmware.

### Issues to consider when performing flash upgrades

The upgrade program rewrites the internal firmware code. If the upgrade process is interrupted then the unit will have invalid code and will not be able to operate. It is therefore good practice to ensure that the upgrade process is always fully completed. A partial or failed upgrade may be rectified by performing another upgrade.

**WARNING:** Running faulty or partially upgraded code may have unpredictable results and may damage your CCS4-USB unit or computing equipment.

# Operation

## Selecting a computer

There are five ways to switch the common peripherals to specific computer channels:

- Using the innovative Free-Flow automatic switching utility 
- Using the control panel 
- [Using hotkeys](#)
- [Using mouse button presses](#)
- [Using the optional RC4 remote control](#)

## To select a computer using the Free-Flow utility

Once configured, Free-Flow allows you to change channels merely by moving the mouse to edge of one screen towards the next screen. As the mouse pointer reaches the edge it will cause the channel to automatically change and will jump to the next screen.

Notes:

Free-Flow cannot be enabled until a layout has been configured and downloaded to the CCS4-USB unit - see [Free-Flow configuration](#).

The mouse will not flow across the screens while any mouse buttons are pressed down - this prevents undesired behaviour when dragging windows around or group-selecting items.

You can determine which peripherals will be switched by Free-Flow independently of those that would be switched with any other method. See **Switch Mode** within the [Switch... settings](#) section.

You can continue to use any of the other channel switching methods while Free-Flow is enabled.

The four upper indicators on the CCS4-USB display panel will scroll across every few seconds to show that Free-Flow is enabled. See [What is Free-Flow?](#) for an introduction to the utility or [Free-Flow configuration](#) for more details about how to prepare it for operation.

You can temporarily disable (and re-enable) Free-Flow using hotkey presses:

- Simultaneously press and hold **Ctrl** and **Alt**, then press **F**

## To select a computer using the control panel

The control panel allows you to determine how the various peripherals are switched to one or more computer channels.

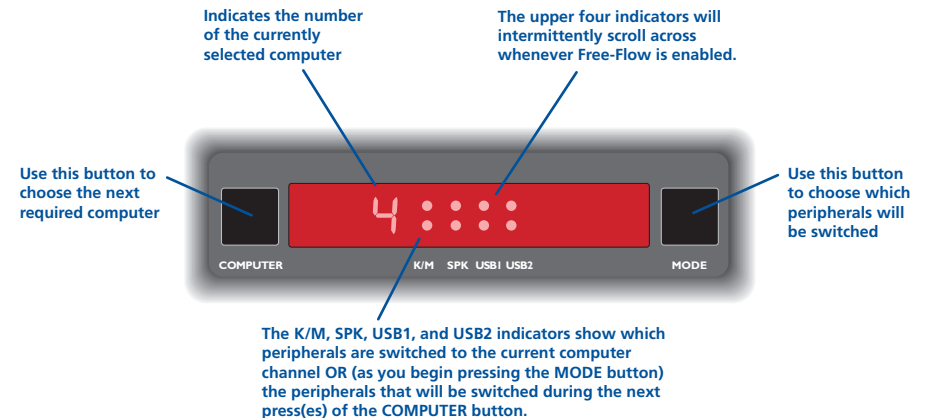

- 1 Optional: If you need to selectively switch some of your peripherals, press the MODE button repeatedly to change the switching mode:

	K/M	SPK	USB1	USB2	
MODE →	●	●	●	●	Will switch all peripherals together
MODE →	●	●	●	●	Will switch keyboard, mouse and speakers
MODE →	●	●	●	●	Will switch only the keyboard and mouse
MODE →	●	●	●	●	Will switch only the speakers
MODE →	●	●	●	●	Will switch only USB peripheral 1
MODE →	●	●	●	●	Will switch only USB peripheral 2

Notes:

If an indicator flashes, it signifies that the respective peripheral is currently switched to another computer channel.

The peripherals to be switched using the Free-Flow method are set independently

- 2 Press the COMPUTER button repeatedly to select the required computer channel.

## To select a computer using hotkeys

Using hotkey combinations, you can quickly switch the keyboard and mouse, speakers and USB peripherals to any computer channel.

There are two main ways to use hotkeys: *Standard* and *Additional*.

### Standard hotkey press combinations

The standard hotkey press combinations allow you to change channels with the minimum of keypresses:

- 1 Simultaneously press and hold **Ctrl** and **Alt** (or other hotkeys, if altered).
- 2 While still holding **Ctrl** and **Alt**, press the number key of the required channel address (or the TAB key), then release all of the keys.

*Note: The numbers on your keyboard's numeric keypad are not valid, use only the numeral keys above the QWERTY section.*

The ports (K/M, audio and/or USB) that are switched using this method depend upon the switching mode that is currently set using the [control panel buttons](#).

The range of standard hotkey combinations are as follows:

*Note: If your hotkeys have been changed, substitute them for **Ctrl** and **Alt** in the examples given here.*

<b>Ctrl</b> <b>Alt</b> <b>1</b>	Selects channel 1
<b>Ctrl</b> <b>Alt</b> <b>2</b>	Selects channel 2
<b>Ctrl</b> <b>Alt</b> <b>3</b>	Selects channel 3
<b>Ctrl</b> <b>Alt</b> <b>4</b>	Selects channel 4
<b>Ctrl</b> <b>Alt</b> <b>0</b>	Isolates the user console from all channels
<b>Ctrl</b> <b>Alt</b> <b>Tab</b>	Selects the next channel (see note ⇔)

### What are hotkeys?

The **Ctrl** and **Alt** keys when pressed in combination are called 'hotkeys' and they signal to the CCS4-USB unit that you wish to control it, rather than the computer. However, if these particular hotkeys clash with another device or program, you can change them to a different combination within the [Configuration](#) menu.

### Additional hotkey press combinations

In addition to the standard hotkey press combinations (shown left), you can also add additional keypresses in order to determine which peripherals are switched:

- 1 Simultaneously press and hold **Ctrl** and **Alt**.
- 2 Press and release a command key:
  - A** to switch all peripherals
  - K** to switch only the keyboard and mouse
  - S** to switch only the speakers
  - U** to switch only USB1 and USB2
- 3 Press and release the required channel number (**1** to **4** using only the keys above the QWERTY section).
- 4 Release **Ctrl** and **Alt**.

The appropriate peripherals will change to the chosen channel.

*Note: Regardless of which peripherals were switched, the front panel indicators will continue to show the switching mode that was last determined using the front panel controls.*

### Disabling/Enabling Free-Flow

Once Free-Flow is in operation, you can temporarily disable (and re-enable) it:

- Simultaneously press and hold **Ctrl** and **Alt**, then press **F**

### Choosing which computers are accessed when using hot keys + tab

The computer channels that are visited when you use the hot keys + tab (or mouse buttons) are determined by a setting within the Configuration menu:

- 1 Enter the [Configuration](#) menu.
- 2 Press **U** and then press either:
  - 7** to choose **Cycle all ports**, or
  - 8** to choose **Cycle only active ports**
- 3 Press **Enter** to accept the setting and return to the main menu section.
- 4 Press **E** and then **Enter** to exit the menu and save changes.

## To select a computer using the mouse buttons

Using the mouse buttons, you can quickly switch the keyboard and mouse, speakers and/or USB peripherals to any computer channel.

*Note: These procedures work only with three-button or IntelliMouse devices and only if the 'Mouse Switching' option has been enabled.*

### To select a computer using the mouse buttons

- 1 Hold down the middle button (or scroll wheel) of the mouse.
- 2 Click the left mouse button to increment the channel number or click the right mouse button to decrement the channel. When the correct channel is reached, release the middle button.

When using this method of switching:

- The computer channels that are visited depend upon the configuration menu setting (see note ⇔).
- The ports (K/M, audio and/or USB) that are switched using this method depend upon the switching mode that is currently set using the [control panel buttons](#).

### Choosing which computers are accessed when using mouse buttons

The computer channels that are visited when you use the mouse buttons (or hotkeys + tab) are determined by a setting within the Configuration menu:

- 1 Enter the [Configuration](#) menu.
- 2 Press **U** and then press either:
  - 7** to choose **Cycle all ports**, or
  - 8** to choose **Cycle only active ports**
- 3 Press **Enter** to accept the setting and return to the main menu section.
- 4 Press **E** and then **Enter** to exit the menu and save changes.

## To lock access to the computers

When privacy is required, you can lock access to the connected computers via the unit.

### To lock the unit

- 1 Simultaneously press and hold **Ctrl** and **Alt** (or other hotkeys, if altered).
- 2 While still holding **Ctrl** and **Alt**, press **L**.  
The display will show **P** (providing a valid password has been previously set). You will not be able to access any computers until the password is correctly entered.

### To unlock the unit

- When prompted, enter the correct password and press **↵**.

### To set a new password

- 1 Enter the [Configuration](#) menu.
- 2 Press **P** and then **Enter**. The display will show **⋮**.
- 3 Enter a new password and then **Enter**.  
The password is not case sensitive and can be any combination of key strokes, including the function keys, but excluding the Num Lock, Caps Lock, Scroll Lock and **↵** keys. If your keyboard has special media keys, these also cannot be used as part of the password.  
When you have typed in your password, press **↵** to store it. Don't worry if you type the password incorrectly, you can always re-enter configure mode and set the password again.
- 4 Press **E** and then **Enter** to exit the menu and save changes.

### To cancel the password

- 1 Enter the [Configuration](#) menu.
- 2 Press **P** and then **Enter**. The display will show **⋮**.
- 3 Press **Enter** to remove the existing password.
- 4 Press **E** and then **Enter** to exit the menu and save changes.

### If you forget the password

To clear an existing password: Connect the OPTIONS port of the unit to the serial port of a computer and transmit the text **clrpwd** to the unit.

# Further information



This chapter contains a variety of information, including the following:

- Getting assistance - see right
- [Appendix 1 – Cable pin-outs](#)
- [Safety information](#)
- [Warranty](#)
- [Radio frequency energy statements](#)

## Getting assistance

If you are still experiencing problems after checking the list of solutions in the Troubleshooting section then we provide a number of other solutions:

- Adder Technology website – [www.adder.com](http://www.adder.com)  
Check the Support section of our website for the latest solutions and driver files.
- Email – [support@adder.com](mailto:support@adder.com)
- Fax      in the UK:     **01954 780081**  
            in the US:     **+1 888 275 1117**
- Phone   in the UK:     **01954 780044**  
            in the US:     **+1 888 932 3337**

WELCOME

INSTALLATION

CONFIGURATION

OPERATION

FURTHER  
INFORMATION

## Appendix 1 – Cable pin-outs

The OPTIONS port uses a 10p10c socket which can accommodate both 10p10c connectors as well as the much more common 8p8c connectors, which are used on Ethernet leads and patch cables. The pin-outs are listed in this section for both types of connector.

### Serial remote control and flash upgrade cable (8p8c)

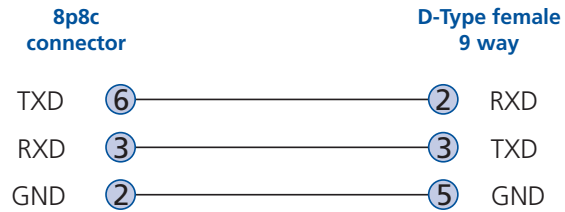

### Serial remote control and flash upgrade cable (10p10c)

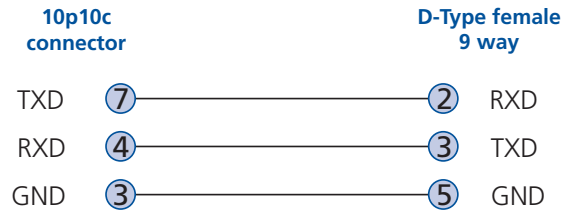

*Note: You can also use the supplied Flash Upgrade Adaptor together with a standard CAT5 patch cable (or 3m patch cable - part number VSC23) to form a serial remote control/flash upgrade cable.*

## Safety information

- For use in dry, oil free indoor environments only.
- Not suitable for use in hazardous or explosive environments or next to highly flammable materials.
- Warning – the power adapter contains live parts.
- No user serviceable parts are contained within the power adapter - do not dismantle.
- Do not use the power adapter if the power adapter case becomes damaged, cracked or broken or if you suspect that it is not operating properly.
- Replace the power adapter with a manufacturer approved type only.
- If you use a power extension cable, make sure the total ampere rating of the devices plugged into the extension cable do not exceed the cable's ampere rating. Also, make sure that the total ampere rating of all the devices plugged into the wall outlet does not exceed the wall outlet's ampere rating.
- Do not attempt to service the CCS4-USB unit, the power adapter or the optional remote control yourself.
- The power adapter can get warm in operation – do not situate it in an enclosed space without any ventilation.
- The CCS4-USB unit does not provide ground isolation and should not be used for any applications that require ground isolation or galvanic isolation.
- When using the power adapter, use only with a grounded outlet. When using a backup power supply (UPS), power the computers, the monitors and the CCS4-USB from the same supply.

## Warranty

Adder Technology Ltd warrants that this product shall be free from defects in workmanship and materials for a period of two years from the date of original purchase. If the product should fail to operate correctly in normal use during the warranty period, Adder will replace or repair it free of charge. No liability can be accepted for damage due to misuse or circumstances outside Adder's control. Also Adder will not be responsible for any loss, damage or injury arising directly or indirectly from the use of this product. Adder's total liability under the terms of this warranty shall in all circumstances be limited to the replacement value of this product. If any difficulty is experienced in the installation or use of this product that you are unable to resolve, please contact your supplier.



WELCOME

INSTALLATION

CONFIGURATION

OPERATION

FURTHER  
INFORMATION

## Emissions and Immunity

All interface cables used with this equipment must be shielded in order to maintain compliance with radio frequency energy emission regulations and ensure a suitably high level of immunity to electromagnetic disturbances.

### European EMC directive 89/336/EEC



This equipment has been tested and found to comply with the limits for a class A computing device in accordance with the specifications in the European standard EN55022. These limits are designed to provide reasonable protection against harmful interference. This equipment generates, uses and can

radiate radio frequency energy and if not installed and used in accordance with the instructions may cause harmful interference to radio or television reception. However, there is no guarantee that harmful interference will not occur in a particular installation. If this equipment does cause interference to radio or television reception, which can be determined by turning the equipment on and off, the user is encouraged to correct the interference with one or more of the following measures: (a) Reorient or relocate the receiving antenna. (b) Increase the separation between the equipment and the receiver. (c) Connect the equipment to an outlet on a circuit different from that to which the receiver is connected. (d) Consult the supplier or an experienced radio/TV technician for help.

### FCC Compliance Statement (United States)

This equipment generates, uses and can radiate radio frequency energy and if not installed and used properly, that is, in strict accordance with the manufacturer's instructions, may cause interference to radio communication. It has been tested and found to comply with the limits for a class A computing device in accordance with the specifications in Subpart J of part 15 of FCC rules, which are designed to provide reasonable protection against such interference when the equipment is operated in a commercial environment. Operation of this equipment in a residential area may cause interference, in which case the user at his own expense will be required to take whatever measures may be necessary to correct the interference. Changes or modifications not expressly approved by the manufacturer could void the user's authority to operate the equipment.

### Canadian Department of Communications RFI statement

This equipment does not exceed the class A limits for radio noise emissions from digital apparatus set out in the radio interference regulations of the Canadian Department of Communications.

*Le présent appareil numérique n'émet pas de bruits radioélectriques dépassant les limites applicables aux appareils numériques de la classe A prescrites dans le règlement sur le brouillage radioélectriques publié par le ministère des Communications du Canada.*



WELCOME

INSTALLATION

CONFIGURATION

OPERATION

FURTHER INFORMATION

© 2010 Adder Technology Limited  
All trademarks are acknowledged  
Release 2.0d  
July 2010  
Part No. MAN-CCS4-USB-ADDER

Adder Technology Limited,  
Technology House,  
Trafalgar Way, Bar Hill,  
Cambridge, CB23 8SQ,  
United Kingdom  
Tel: +44 (0)1954 780044  
Fax: +44 (0)1954 780081

Adder Corporation,  
350R Merrimac Street,  
Newburyport,  
MA 01950,  
United States of America  
Tel: +1-888-932-3337  
Fax: +1-888-275-1117

Adder Asia Pacific  
6 New Industrial Road,  
Hoe Huat Industrial Building  
#07-01,  
Singapore 536199  
Tel: +65 6288 5767  
Fax: +65 6284 1150